

CJTHT

400 °C/2h and 300 °C/2h axial fans with acoustically insulated box



Extraction units with axial fans to work immersed in fire risk areas.

Fan:

- Fan with tubular sheet steel casing.
- Galvanised sheet steel structure with thermal insulation and acoustic insulation.
- Variable angle impeller made of cast aluminium.
- Approved in accordance with standard EN 12101-3, with certifications no.: 0370- CPR-0312 (F400) and 0370-CPR-0974 (F300).

Motor:

- Class H motors for S1 continuous operation and S2 emergency use. With ball bearings, IP55 protection and 1 or 2 speeds, depending on model.
- Motors with IE3 efficiency for powers equal to or greater than 0.75 kW, except single-phase, 2-speed and 8-pole.
- Three-phase 230/400 V 50 Hz (up to 3 kW) and 400/690 V 50 Hz (powers greater than 3 kW).
- Maximum temperature of air to be carried: S1 -20 °C +40 °C continuous service, also suitable for warm climates with temperatures up to 50 °C. S2 operation, 300 °C/2h, 400 °C/2h.

Finish:

- Fan: anti-corrosive in polyester resin polymerized at 190 °C, after degreasing with phosphate-free nanotechnological treatment.
- Box: anti-corrosive in galvanised sheet steel.

Available versions:

- CJTHT: axial fans with acoustically insulated boxes.
- CJTHT/ATEX: axial fans with acoustically insulated boxes and ATEX certification, category 3 Ex II3G for zone 2 (only 400 °C/2h and 300 °C/2h).
- CJTHT/PLUS Axial fans with acoustic attenuators.

On request:

- Airflow direction from impeller to motor.
- 100% reversible impellers.

Order code

From size 40 to size 100

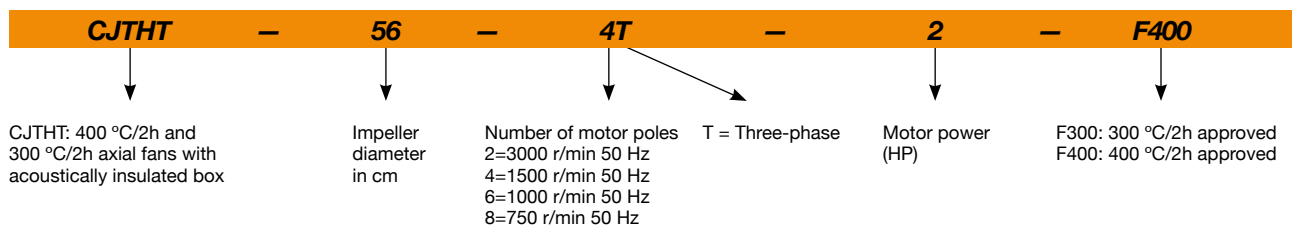

Size 125

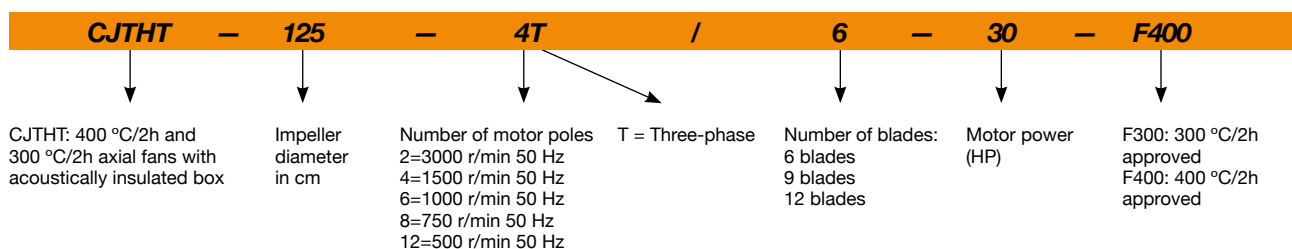

Technical characteristics

Model	Speed (r/min)	Maximum admissible current (A)			Installed power (kW)	Blade tilt angle (°)	Maximum flow rate (m³/h)	Sound pressure level ¹ dB (A)	Approx. weight (Kg)
		230V	400V	690V					
CJTHT-40-2/4T-1.5	2900 / 1435		2.89 / 1.04		1.10 / 0.25	20	7040 / 3480	71 / 56	50
CJTHT-40-4T-0.75	1420	2.84	1.64		0.55	32	4800	55	41
CJTHT-40-6T-0.75	930	2.90	1.75		0.55	32	3150	46	49
CJTHT-40-6/12T-0.75	940 / 455		2.35 / 1.15		0.60 / 0.15	32	3150 / 1520	46 / 31	53
CJTHT-45-2/4T-2	2940 / 1465		3.58 / 1.19		1.50 / 0.37	16	9400 / 4680	71 / 56	53
CJTHT-45-4T-0.75	1420	2.84	1.64		0.55	36	7450	58	43
CJTHT-45-6T-0.75	930	2.90	1.75		0.55	30	4450	48	51
CJTHT-45-6/12T-0.75	940 / 455		2.35 / 1.15		0.60 / 0.15	30	4450 / 2150	48 / 33	55
CJTHT-50-4T-0.75	1420	2.84	1.64		0.55	22	8390	60	48
CJTHT-50-6T-0.75	930	2.90	1.75		0.55	32	7000	52	52
CJTHT-56-4T-1 IE3	1430	3.08	1.79		0.75	22	11250	63	59
CJTHT-56-4T-1.5 IE3	1420	4.10	2.37		1.10	30	13600	63	61
CJTHT-56-4/8T-1.5	1440 / 705		2.69 / 1.12		1.10 / 0.25	30	13600 / 6640	63 / 48	65
CJTHT-56-4T-2 IE3	1425	5.89	3.38		1.50	36	15030	64	63
CJTHT-56-6T-0.75	930	2.90	1.75		0.55	38	10140	54	61
CJTHT-56-6/12T-0.75	940 / 455		2.35 / 1.15		0.60 / 0.15	38	10140 / 4890	54 / 39	65
CJTHT-63-4T-1 IE3	1430	3.08	1.79		0.75	14	15190	67	63
CJTHT-63-4T-1.5 IE3	1420	4.10	2.37		1.10	20	17800	66	66
CJTHT-63-4/8T-1.5	1440 / 705		2.69 / 1.12		1.10 / 0.25	20	17800 / 8680	66 / 51	69
CJTHT-63-4T-2 IE3	1425	5.89	3.38		1.50	24	19280	66	67
CJTHT-63-4/8T-2	1415 / 715		3.40 / 1.65		1.50 / 0.30	24	19280 / 9740	66 / 52	74
CJTHT-63-4T-3 IE3	1435	7.86	4.52		2.20	32	22150	68	73
CJTHT-63-4/8T-3	1415 / 700		4.80 / 1.85		2.20 / 0.45	32	22150 / 10920	68 / 53	87
CJTHT-63-4T-4 IE3	1430	11.01	6.33		3.00	38	24240	69	78
CJTHT-63-4/8T-4	1420 / 710		6.45 / 2.28		3.00 / 0.60	38	24240 / 12070	69 / 54	91
CJTHT-63-6T-0.75	930	2.90	1.75		0.55	28	13590	57	66
CJTHT-63-6/12T-0.75	940 / 455		2.35 / 1.15		0.60 / 0.15	28	13590 / 6550	57 / 42	69
CJTHT-63-6T-1 IE3	940	3.36	1.93		0.75	38	15890	58	67
CJTHT-63-6/12T-1	935 / 455		3.75 / 2.76		0.80 / 0.20	38	15890 / 7700	58 / 43	71
CJTHT-71-4T-1.5 IE3	1420	4.10	2.37		1.10	12	19480	71	82
CJTHT-71-4/8T-1.5	1440 / 705		2.69 / 1.12		1.10 / 0.25	12	19480 / 9500	71 / 56	86
CJTHT-71-4T-2 IE3	1425	5.89	3.38		1.50	14	20900	70	84
CJTHT-71-4/8T-2	1415 / 715		3.40 / 1.65		1.50 / 0.30	14	20900 / 10560	70 / 56	91
CJTHT-71-4T-3 IE3	1435	7.86	4.52		2.20	22	25100	70	90
CJTHT-71-4/8T-3	1415 / 700		4.80 / 1.85		2.20 / 0.45	22	25100 / 12370	70 / 55	103
CJTHT-71-4T-4 IE3	1430	11.01	6.33		3.00	28	27480	70	95
CJTHT-71-4/8T-4	1420 / 710		6.45 / 2.28		3.00 / 0.60	28	27480 / 13680	70 / 55	108
CJTHT-71-6T-0.75	930	2.90	1.75		0.55	20	16100	60	82
CJTHT-71-6/12T-0.75	940 / 455		2.35 / 1.15		0.60 / 0.15	20	16100 / 7760	60 / 45	86
CJTHT-71-6T-1 IE3	940	3.36	1.93		0.75	26	17300	60	84
CJTHT-71-6/12T-1	935 / 455		3.75 / 2.76		0.80 / 0.20	26	17300 / 8380	60 / 45	87
CJTHT-71-6T-1.5 IE3	945	4.73	2.72		1.10	34	19930	61	86
CJTHT-71-6/12T-1.5	940 / 460		3.52 / 2.00		1.20 / 0.30	34	19930 / 9760	61 / 46	97
CJTHT-80-4T-3 IE3	1435	7.86	4.52		2.20	12	25450	75	98
CJTHT-80-4/8T-3	1415 / 700		4.80 / 1.85		2.20 / 0.45	12	25450 / 12550	75 / 60	111
CJTHT-80-4T-4 IE3	1430	11.01	6.33		3.00	16	30250	74	103
CJTHT-80-4/8T-4	1420 / 710		6.45 / 2.28		3.00 / 0.60	16	30250 / 15060	74 / 59	115
CJTHT-80-4T-5.5 IE3	1440		7.95	4.61	4.00	18	32750	73	113
CJTHT-80-4/8T-5.5	1450 / 715		7.88 / 2.87		3.80 / 1.00	18	32750 / 16150	73 / 58	147
CJTHT-80-6T-1.5 IE3	945	4.73	2.72		1.10	18	21450	63	95
CJTHT-80-6/12T-1.5	940 / 460		3.52 / 2.00		1.20 / 0.30	18	21450 / 10500	63 / 48	105
CJTHT-80-6T-2 IE3	945	6.25	3.62		1.50	26	25950	64	99
CJTHT-80-6/12T-2	960 / 470		4.46 / 3.43		1.60 / 0.40	26	25950 / 12700	64 / 49	113
CJTHT-80-6T-3 IE3	950	9.78	5.62		2.20	32	29930	65	113

Technical characteristics

Model	Speed (r/min)	Maximum admissible current (A)			Installed power (kW)	Blade tilt angle (°)	Maximum flow rate (m³/h)	Sound pressure level ¹ dB (A)		Approx. weight (Kg)
		230V	400V	690V				Inlet		
CJTHT-80-6/12T-3	940 / 475		5.62 / 3.32		2.20 / 0.55	32	29930 / 15120	65 / 51	118	
CJTHT-80-8T-0.75	700	3.48	2.00		0.55	20	17540	57	99	
CJTHT-80-8T-1	710	5.06	2.92		0.75	28	20650	58	111	
CJTHT-90-4T-4 IE3	1430	11.01	6.33		3.00	8	33580	79	127	
CJTHT-90-4/8T-4	1420 / 710		6.45 / 2.28		3.00 / 0.60	8	33580 / 16720	79 / 64	139	
CJTHT-90-4T-5.5 IE3	1440		7.95	4.61	4.00	12	38890	78	137	
CJTHT-90-4/8T-5.5	1450 / 715		7.88 / 2.87		3.80 / 1.00	12	38890 / 19170	78 / 63	171	
CJTHT-90-4T-7.5 IE3	1430		10.40	6.04	5.50	18	46140	77	171	
CJTHT-90-4/8T-7.5	1455 / 725		11.40 / 3.86		5.50 / 1.10	18	46140 / 22910	77 / 62	190	
CJTHT-90-4T-10 IE3	1460		14.20	8.17	7.50	22	50140	76	208	
CJTHT-90-4/8T-10	1455 / 725		15.10 / 5.16		7.50 / 1.50	22	50140 / 24900	76 / 61	198	
CJTHT-90-6T-2 IE3	945	6.25	3.62		1.50	16	28780	66	123	
CJTHT-90-6/12T-2	960 / 470		4.46 / 3.43		1.60 / 0.40	16	28780 / 14090	66 / 51	137	
CJTHT-90-6T-3 IE3	950	9.78	5.62		2.20	24	34000	66	137	
CJTHT-90-6/12T-3	940 / 475		5.62 / 3.32		2.20 / 0.55	24	34000 / 17180	66 / 52	142	
CJTHT-90-6T-4 IE3	945	12.80	6.36		3.00	30	38900	69	171	
CJTHT-90-6/12T-4	970 / 485		7.37 / 3.53		2.80 / 0.70	30	38900 / 19450	69 / 54	171	
CJTHT-90-8T-1	710	5.06	2.92		0.75	18	22900	60	135	
CJTHT-90-8T-2	700	7.32	4.21		1.50	30	29490	63	139	
CJTHT-90-8T-3	705	9.30	5.35		2.20	32	30850	64	171	
CJTHT-100-4T-7.5 IE3	1430		10.40	6.04	5.50	10	46850	82	179	
CJTHT-100-4/8T-7.5	1455 / 725		11.40 / 3.86		5.50 / 1.10	10	46850 / 23260	82 / 67	198	
CJTHT-100-4T-10 IE3	1460		14.20	8.17	7.50	16	57400	79	216	
CJTHT-100-4/8T-10	1455 / 725		15.10 / 5.16		7.50 / 1.50	14	54710 / 27170	80 / 65	206	
CJTHT-100-4T-15 IE3	1455		20.70	11.99	11.00	22	66300	79	251	
CJTHT-100-4/8T-15	1470 / 730		20.70 / 7.19		11.00 / 3.00	22	66300 / 32880	79 / 64	251	
CJTHT-100-4T-20 IE3	1460		27.80	16.03	15.00	28	76150	80	258	
CJTHT-100-4/8T-20	1470 / 725		31.72 / 11.75		15.00 / 3.80	28	76150 / 37560	80 / 65	258	
CJTHT-100-4T/9-15 IE3	1460		20.70	11.99	11.00	18	55340	80	260	
CJTHT-100-4T/9-20 IE3	1460		27.80	16.03	15.00	22	63260	80	268	
CJTHT-100-4T/9-25 IE3	1475		35.40	20.39	18.50	26	70620	80	308	
CJTHT-100-4T/9-30 IE3	1475		42.20	24.44	22.00	30	74840	82	316	
CJTHT-100-6T-3 IE3	950	9.78	5.62		2.20	16	37600	70	145	
CJTHT-100-6/12T-3	940 / 475		5.62 / 3.32		2.20 / 0.55	16	37600 / 18990	70 / 56	150	
CJTHT-100-6T-4 IE3	945	12.80	6.36		3.00	20	41150	69	179	
CJTHT-100-6/12T-4	970 / 485		7.37 / 3.53		2.80 / 0.70	20	41150 / 20580	69 / 54	179	
CJTHT-100-6T-5.5 IE3	970		8.37	4.82	4.00	26	47780	70	187	
CJTHT-100-6T/9-5.5 IE3	970		11.00	6.35	4.00	20	39020	70	196	
CJTHT-100-6T/9-7.5 IE3	970		12.30	7.07	5.50	26	46770	71	200	
CJTHT-100-6T/9-10 IE3	970		15.20	8.83	7.50	34	52260	74	225	
CJTHT-125-4T/6-20 IE3	1460		27.80	16.03	15.00	10	78600	87	466	
CJTHT-125-4/8T/6-20	1470 / 725		31.72 / 11.75		15.00 / 3.80	10	78600 / 38770	87 / 72	485	
CJTHT-125-4T/6-25 IE3	1465		35.40	20.39	18.50	14	92550	86	549	
CJTHT-125-4/8T/6-27	1470 / 730		39.70 / 14.10		20.00 / 5.00	16	98830 / 48910	85 / 70	557	
CJTHT-125-4T/6-30 IE3	1470		42.20	24.44	22.00	16	98830	85	554	
CJTHT-125-4/8T/6-37	1475 / 735		54.55 / 18.50		28.00 / 6.50	20	110890 / 55260	85 / 70	633	
CJTHT-125-4T/6-40 IE3	1475		53.30	31.02	30.00	22	117450	85	606	
CJTHT-125-4T/6-50 IE3	1480		66.80	38.70	37.00	26	131050	85	734	
CJTHT-125-4T/6-60 IE3	1475		80.90	46.90	45.00	28	135820	85	767	
CJTHT-125-4T/6-75 IE3	1480		98.60	57.20	55.00	34	152100	88	848	
CJTHT-125-4T/9-25 IE3	1465		35.40	20.39	18.50	10	79650	87	558	
CJTHT-125-4T/9-30 IE3	1470		42.20	24.44	22.00	12	88290	86	563	
CJTHT-125-4/8T/9-27	1470 / 730		39.70 / 14.10		20.00 / 5.00	12	88290 / 43690	86 / 71	566	
CJTHT-125-4/8T/9-37	1475 / 735		54.55 / 18.50		28.00 / 6.50	16	104040 / 51840	85 / 70	642	

Technical characteristics

Model	Speed (r/min)	Maximum admissible current (A)			Installed power (kW)	Blade tilt angle (°)	Maximum flow rate (m³/h)	Sound pressure level¹ dB (A) Inlet	Approx. weight (Kg)
		230V	400V	690V					
CJTHT-125-4T/9-40 IE3	1475		53.30	31.02	30.00	16	104040	85	615
CJTHT-125-4T/9-50 IE3	1480		66.80	38.70	37.00	20	118400	85	743
CJTHT-125-4T/9-60 IE3	1475		80.90	46.90	45.00	24	134970	85	776
CJTHT-125-4T/9-75 IE3	1480		98.60	57.20	55.00	28	146770	86	857
CJTHT-125-4T/9-100 IE3	1480		128.00	74.22	75.00	34	158560	88	1018
CJTHT-125-4T/12-50 IE3	1480		66.80	38.70	37.00	18	101660	86	772
CJTHT-125-4T/12-60 IE3	1475		80.90	46.90	45.00	20	109180	86	785
CJTHT-125-4T/12-75 IE3	1480		98.60	57.20	55.00	26	131240	86	866
CJTHT-125-4T/12-100 IE3	1480		128.00	74.22	75.00	32	154100	88	1036
CJTHT-125-6T/6-5.5 IE3	970		8.37	4.82	4.00	10	51500	77	402
CJTHT-125-6T/6-7.5 IE3	970		12.30	7.07	5.50	14	60640	75	410
CJTHT-125-6/12T/6-7.5	970 / 480		14.50 / 5.17		5.50 / 1.00	14	60640 / 30010	75 / 60	454
CJTHT-125-6T/6-10 IE3	960		15.20	8.83	7.50	20	72650	74	458
CJTHT-125-6/12T/6-10	970 / 490		13.60 / 5.69		7.20 / 1.80	20	72650 / 36510	74 / 60	466
CJTHT-125-6T/6-15 IE3	955		22.50	13.07	11.00	26	85850	74	475
CJTHT-125-6/12T/6-15	970 / 485		23.10 / 8.41		11.00 / 3.00	26	85850 / 42710	74 / 59	566
CJTHT-125-6T/6-20 IE3	950		29.00	16.78	15.00	30	92850	76	542
CJTHT-125-6/12T/6-24	970 / 480		41.60 / 13.21		17.60 / 2.85	34	99650 / 49320	78 / 63	631
CJTHT-125-6T/9-10 IE3	960		15.20	8.83	7.50	14	63490	77	467
CJTHT-125-6/12T/9-10	970 / 490		13.60 / 5.69		7.20 / 1.80	14	63490 / 31910	77 / 63	475
CJTHT-125-6T/9-15 IE3	955		22.50	13.07	11.00	20	77550	75	484
CJTHT-125-6/12T/9-15	970 / 485		23.10 / 8.41		11.00 / 3.00	20	77550 / 38580	75 / 60	575
CJTHT-125-6T/9-20 IE3	950		29.00	16.78	15.00	26	92950	75	551
CJTHT-125-6/12T/9-24	970 / 480		41.60 / 13.21		17.60 / 2.85	30	98500 / 48750	76 / 61	640
CJTHT-125-6T/9-25 IE3	975		36.10	20.77	18.50	32	101450	77	627
CJTHT-125-6T/9-30 IE3	975		42.30	24.35	22.00	36	106520	80	638
CJTHT-125-6T/12-10 IE3	970		15.20	8.83	7.50	12	49630	79	496
CJTHT-125-6T/12-15 IE3	970		22.50	13.07	11.00	18	67310	77	513
CJTHT-125-6T/12-20 IE3	970		29.00	16.78	15.00	24	81840	76	580
CJTHT-125-6T/12-25 IE3	975		36.10	20.77	18.50	30	96770	77	656
CJTHT-125-6T/12-30 IE3	975		42.30	24.35	22.00	32	102040	78	667
CJTHT-125-6T/12-40 IE3	985		56.00	32.50	30.00	34	106350	79	782

1 The noise level values are pressures in dB(A) measured at a distance of 3 metres in a free field.



Erp. (Energy Related Products)

Information on Directive 2009/125/EC can be downloaded from the SODECA website or the QuickFan selector programme.

Acoustic characteristics

Sound power spectrum Lw(A) in dB(A) per Hz frequency band
Values measured at inlet with maximum flow rate

	63	125	250	500	1000	2000	4000	8000		63	125	250	500	1000	2000	4000	8000
40-2-1.5	47	63	75	83	88	86	82	75	50-4-0.75	49	61	69	75	75	75	70	62
40-4-1.5 (2V)	32	48	60	68	73	71	67	60	50-6-0.75	41	53	61	67	67	67	62	54
40-4-0.75	37	53	63	70	71	68	67	68	56-4-1	51	63	72	78	78	78	72	64
40-6-0.75	28	44	54	61	62	59	58	59	56-4-1.5	51	63	72	78	78	78	72	64
40-12-0.75 (2V)	12	28	38	45	46	43	42	43	56-8-1.5 (2V)	35	47	56	62	62	62	56	48
45-2-2	47	60	74	86	87	86	82	74	56-4-2	52	64	73	79	79	79	73	65
45-4-2 (2V)	32	45	59	71	72	71	67	59	56-6-0.75	45	55	65	69	70	68	61	53
45-4-0.75	47	59	67	73	73	73	68	60	56-12-0.75 (2V)	29	39	49	53	54	52	45	37
45-6-0.75	37	49	57	63	63	63	58	50	63-4-1	48	64	76	82	84	81	74	66
45-12-0.75 (2V)	21	33	41	47	47	47	42	34	63-4-1.5	47	63	75	81	83	80	73	65

Acoustic characteristics

Sound power spectrum Lw(A) in dB(A) per Hz frequency band
Values measured at inlet with maximum flow rate

	63	125	250	500	1000	2000	4000	8000		63	125	250	500	1000	2000	4000	8000
63-8-1.5 (2V)	31	47	59	65	67	64	57	49	100-4/9-15	65	81	88	95	96	94	90	82
63-4-2	54	66	75	81	81	81	75	67	100-4/9-20	72	84	88	94	95	95	92	84
63-8-2 (2V)	39	51	60	66	66	66	60	52	100-4/9-25	72	84	88	94	95	95	92	84
63-4-3	56	68	77	83	83	83	77	69	100-4/9-30	74	86	90	96	97	97	94	86
63-8-3 (2V)	41	53	62	68	68	68	62	54	100-6-3	57	72	82	85	86	83	75	67
63-4-4	57	69	78	84	84	84	78	70	100-12-3 (2V)	42	57	67	70	71	68	60	52
63-8-4 (2V)	42	54	63	69	69	69	63	55	100-6-4	56	71	81	84	85	82	74	66
63-6-0.75	48	58	68	72	73	71	64	56	100-12-4 (2V)	41	56	66	69	70	67	59	51
63-12-0.75 (2V)	32	42	52	56	57	55	48	40	100-6-5.5	57	72	82	85	86	83	75	67
63-6-1	49	59	69	73	74	72	65	57	100-6/9-5.5	57	72	82	85	86	83	75	67
63-12-1 (2V)	32	42	52	56	57	55	48	40	100-6/9-7.5	58	73	83	86	87	84	76	68
71-4-1.5	57	73	80	86	86	86	82	74	100-6/9-10	61	76	86	89	90	87	79	71
71-8-1.5 (2V)	41	57	64	70	70	70	66	58	125-4/6-20	69	85	96	103	104	102	95	87
71-4-2	56	72	79	85	85	85	81	73	125-8/6-20 (2V)	54	70	81	88	89	87	80	72
71-8-2 (2V)	41	57	64	70	70	70	66	58	125-4/6-25	68	84	95	102	103	101	94	86
71-4-3	56	72	79	85	85	85	81	73	125-4/6-27	67	83	94	101	102	100	93	85
71-8-3 (2V)	41	57	64	70	70	70	66	58	125-8/6-27 (2V)	52	68	79	86	87	85	78	70
71-4-4	63	75	79	85	85	86	83	75	125-4/6-30	67	83	94	101	102	100	93	85
71-8-4 (2V)	48	60	64	70	70	71	68	60	125-4/6-37	67	83	94	101	102	100	93	85
71-6-0.75	46	53	73	76	76	71	63	55	125-8/6-37 (2V)	52	68	79	86	87	85	78	70
71-12-0.75 (2V)	30	37	57	60	60	55	47	39	125-4/6-40	67	83	94	101	102	100	93	85
71-6-1	46	64	73	76	76	71	64	55	125-4/6-50	67	83	94	101	102	100	93	85
71-12-1 (2V)	29	47	56	59	59	54	47	38	125-4/6-60	67	83	94	101	102	100	93	85
71-6-1.5	47	65	74	77	77	72	65	56	125-4/6-75	70	86	97	104	105	103	96	88
71-12-1.5 (2V)	32	50	59	62	62	57	50	41	125-4/9-25	67	81	94	102	104	101	96	88
80-4-3	55	71	84	91	91	88	82	74	125-4/9-27	66	80	93	101	103	100	95	87
80-8-3 (2V)	40	56	69	76	76	73	67	59	125-8/9-27 (2V)	51	65	78	86	88	85	80	72
80-4-4	54	70	83	90	90	87	81	73	125-4/9-30	66	80	93	101	103	100	95	87
80-8-4 (2V)	39	55	68	75	75	72	66	58	125-4/9-37	65	79	92	100	102	99	94	86
80-4-5.5	53	69	82	89	89	86	80	72	125-8/9-37 (2V)	50	64	77	85	87	84	79	71
80-8-5.5 (2V)	38	54	67	74	74	71	65	57	125-4/9-40	65	79	92	100	102	99	94	86
80-6-1.5	53	68	75	78	79	76	70	62	125-4/9-50	65	79	92	100	102	99	94	86
80-12-1.5 (2V)	38	53	60	63	64	61	55	47	125-4/9-60	73	86	95	99	101	100	96	89
80-6-2	59	69	75	79	80	78	73	65	125-4/9-75	74	87	96	100	102	101	97	90
80-12-2 (2V)	43	53	59	63	64	62	57	49	125-4/9-100	76	89	98	102	104	103	99	92
80-6-3	60	70	76	80	81	79	74	66	125-4/12-50	66	80	93	101	103	100	95	87
80-12-3 (2V)	45	55	61	65	66	64	59	51	125-4/12-60	66	80	93	101	103	100	95	87
80-8-0.75	46	59	67	72	74	71	64	53	125-4/12-75	74	87	96	100	102	101	97	90
80-8-1	47	60	68	73	75	72	65	54	125-4/12-100	76	89	98	102	104	103	99	92
90-4-4	61	77	88	94	95	93	88	80	125-6/6-5.5	64	79	89	92	93	90	85	77
90-8-4 (2V)	46	62	73	79	80	78	73	65	125-6/6-7.5	62	77	87	90	91	88	83	75
90-4-5.5	60	76	87	93	94	92	87	79	125-12/6-7.5 (2V)	47	62	72	75	76	73	68	60
90-8-5.5 (2V)	45	61	72	78	79	77	72	64	125-6/6-10	61	76	86	89	90	87	82	74
90-4-7.5	59	75	86	92	93	91	86	78	125-12/6-10 (2V)	46	61	71	74	75	72	67	59
90-8-7.5 (2V)	44	60	71	77	78	76	71	63	125-6/6-15	61	76	86	89	90	87	82	74
90-4-10	58	74	85	91	92	90	85	77	125-12/6-15 (2V)	45	60	70	73	74	71	66	58
90-8-10 (2V)	43	59	70	76	77	75	70	62	125-6/6-20	63	78	88	91	92	89	84	76
90-6-2	52	67	78	82	82	78	71	63	125-6/6-24	65	80	90	93	94	91	86	78
90-12-2 (2V)	36	51	62	66	66	62	55	47	125-12/6-24 (2V)	50	65	75	78	79	76	71	63
90-6-3	52	67	78	82	82	78	71	63	125-6/9-10	61	76	87	93	94	88	84	77
90-12-3 (2V)	37	52	63	67	67	63	56	48	125-12/9-10 (2V)	46	61	72	78	79	73	69	62
90-6-4	60	70	80	85	85	82	76	68	125-6/9-15	59	74	85	91	92	86	82	75
90-12-4 (2V)	45	55	65	70	70	67	61	53	125-12/9-15 (2V)	43	58	69	75	76	70	66	59
90-8-1	42	63	70	75	78	74	67	56	125-6/9-20	59	74	85	91	92	86	82	75
90-8-2	51	66	73	78	81	77	70	59	125-6/9-24	60	75	86	92	93	87	83	76
90-8-3	53	67	74	79	82	78	71	60	125-12/9-24 (2V)	45	60	71	77	78	72	68	61
100-4-7.5	67	83	90	97	98	96	92	84	125-6/9-25	61	76	87	93	94	88	84	77
100-8-7.5 (2V)	52	68	75	82	83	81	77	69	125-6/9-30	64	79	90	96	97	91	87	80
100-4-10	65	81	88	95	96	94	90	82	125-6/12-10	63	78	89	95	96	90	86	79
100-8-10 (2V)	50	66	73	80	81	79	75	67	125-6/12-15	61	76	87	93	94	88	84	77
100-4-15	71	83	87	93	94	94	91	83	125-6/12-20	60	75	86	92	93	87	83	76
100-8-15 (2V)	56	68	72	78	79	79	76	68	125-6/12-25	61	76	87	93	94	88	84	77
100-4-20	72	84	88	94	95	95	92	84	125-6/12-30	62	77	88	94	95	89	85	78
100-8-20 (2V)	57	69	73	79	80	80	77	69	125-6/12-40	63	78	89	95	96	90	86	79

Dimensions mm

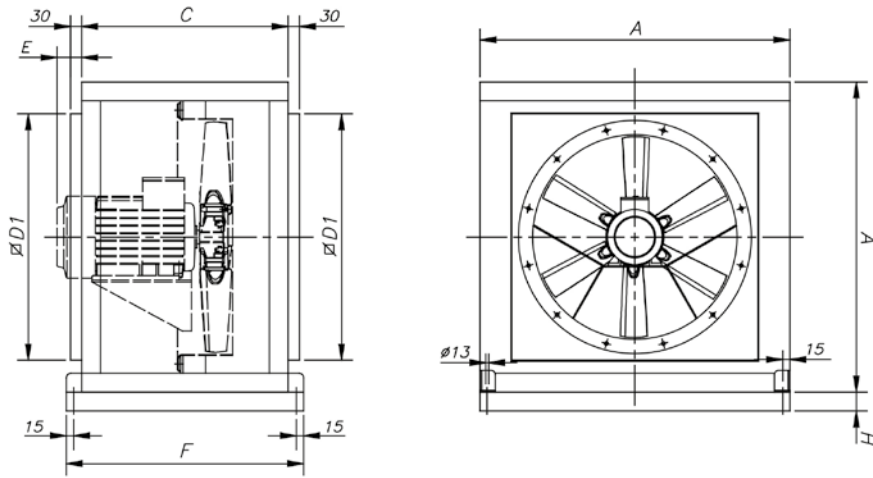

	A	C	ØD1	E	F	H
CJTHT-40/45/50	700	550	565	-	630	-
CJTHT-56/63	825	550	690	140	630	-
CJTHT-71/80	1000	650	850	-	730	-
CJTHT-90/100	1200	750	1050	-	830	-
CJTHT-125 ≤20 HP	1600	1200	1400	-	1280	-
CJTHT-125 >20 HP	1600	1200	1400	123	1280	100

Accessories



INT



IAT



CABLE BOX



C2V



VSD3/A-RFT
- VSD1/A-RFM



CENTRAL CO



AET



P-400



BOXPARK

Configuration with BOXPARK



Control panels for car park ventilation systems with triple purpose: daily ventilation, CO concentration control and smoke extraction in case of fire

Control panels in metal enclosure with all the necessary elements for the management and control of fans in car park ventilation systems, whether they are based on duct networks or impulse fans, for the control of CO concentration levels and smoke extraction in case of fire. Customised panels for all power ratings and number of fans according to project requirements.

More information see BOXPARK series.

Installation examples with BOXPARK

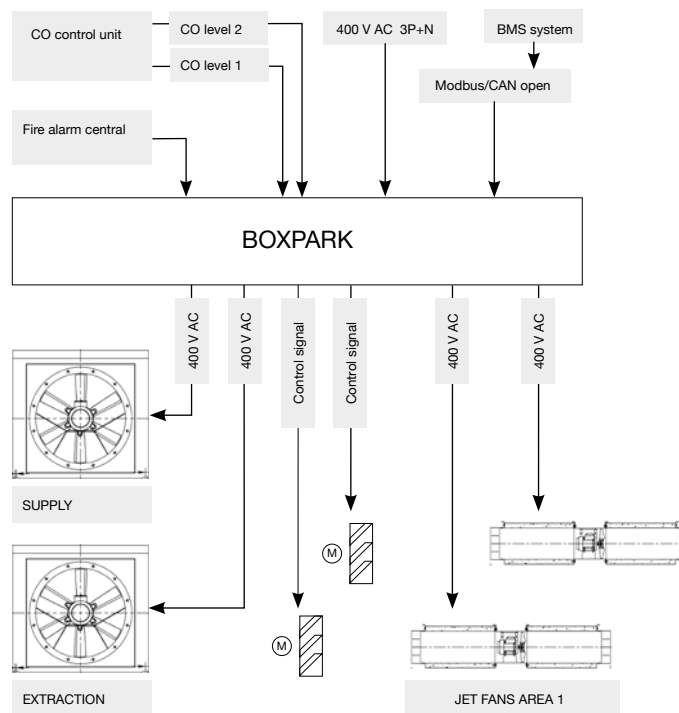

EXAMPLE OF SELECTION

Characteristic curves

Q= Flow rate in m³/h, m³/s and cfm

Pe= Static pressure in mm H₂O, Pa and inwg

Impeller diameter in cm: 71

Number of motor poles: 6

Number of blades: 6

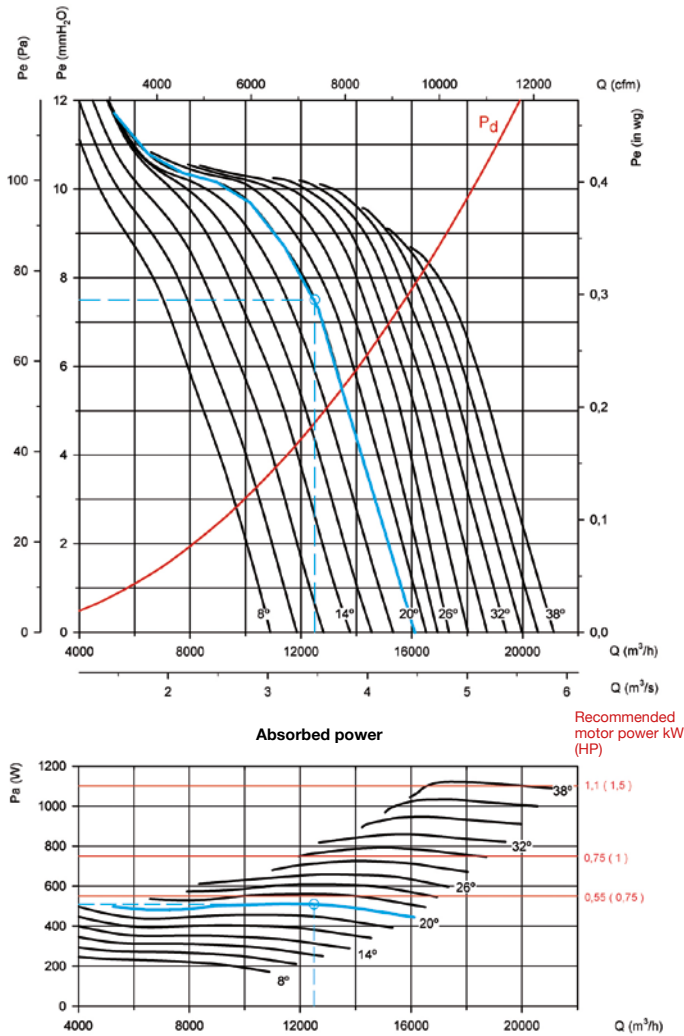

Initial data

Working point:

- Flow rate: 12,500 m³/h
- Loss of load: 7.5 mmH₂O

Steps for the selection of equipment

On the pressure graph:

- Mark the working point, defined by the airflow (12,500 m³/h) and the loss of load (7.5 mmH₂O).
- Select the curve of the equipment which is closest above the working point. In our case, a curve with a blade angle of 20° is obtained.

On the power graph:

- Mark the working point, defined by the airflow (12,500 m³/h) and the selected blade angle (20°).
- Read the absorbed power on the power axis on the left. Pa= 510 W at the working point.
- Look for the straight red line which is closest to the working point above. On the right-hand side of the graph, the value of the installed motor power is obtained. In our case, this is 0.55 kW or 0.75 HP.

EXAMPLE OF ORDER CODE

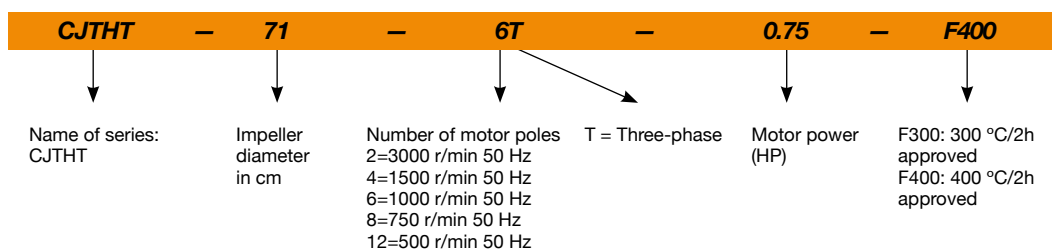

Characteristic curves

Q= Flow rate in m³/h, m³/s and cfm

Pe= Static pressure in mm H₂O, Pa and inwg

Impeller diameter in cm: 40

Number of motor poles: 2

Number of blades: 6

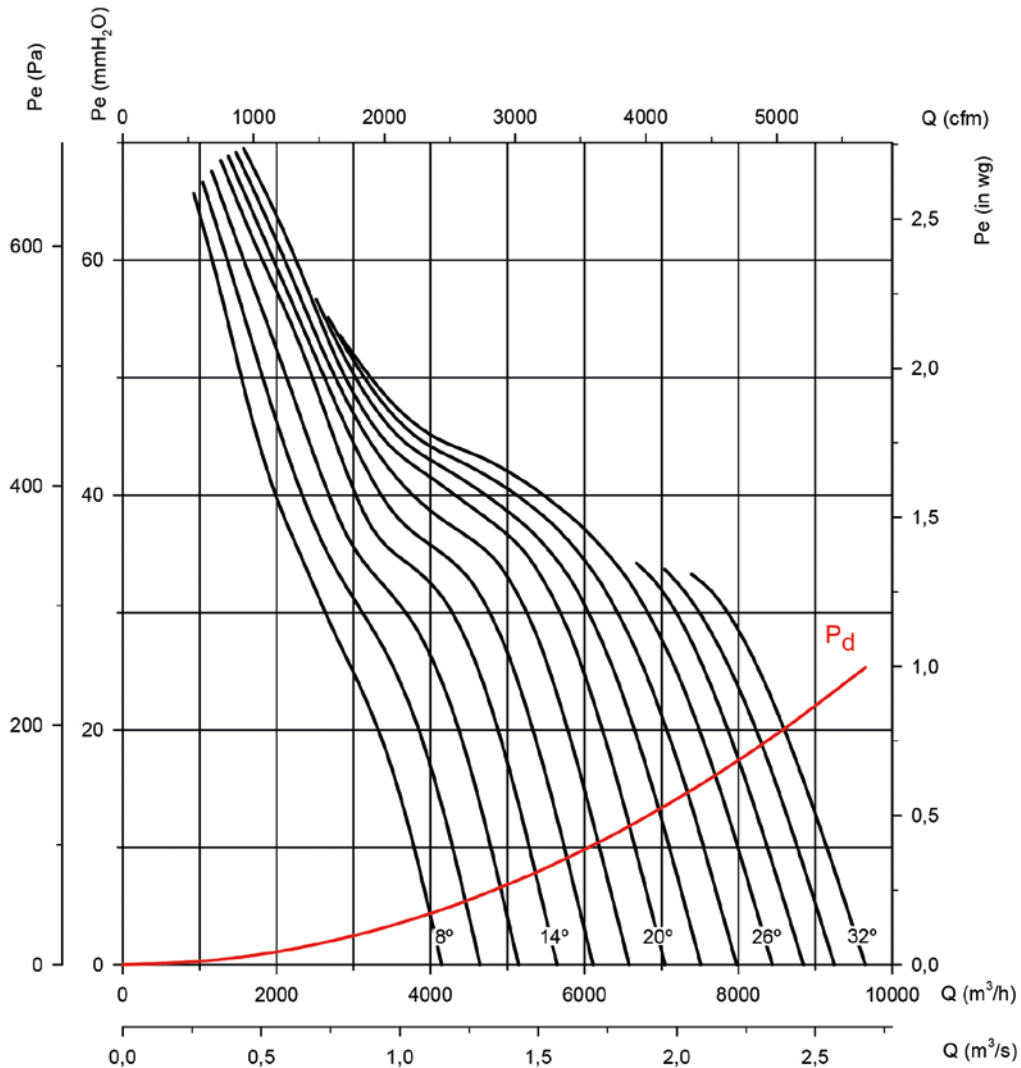

Absorbed power

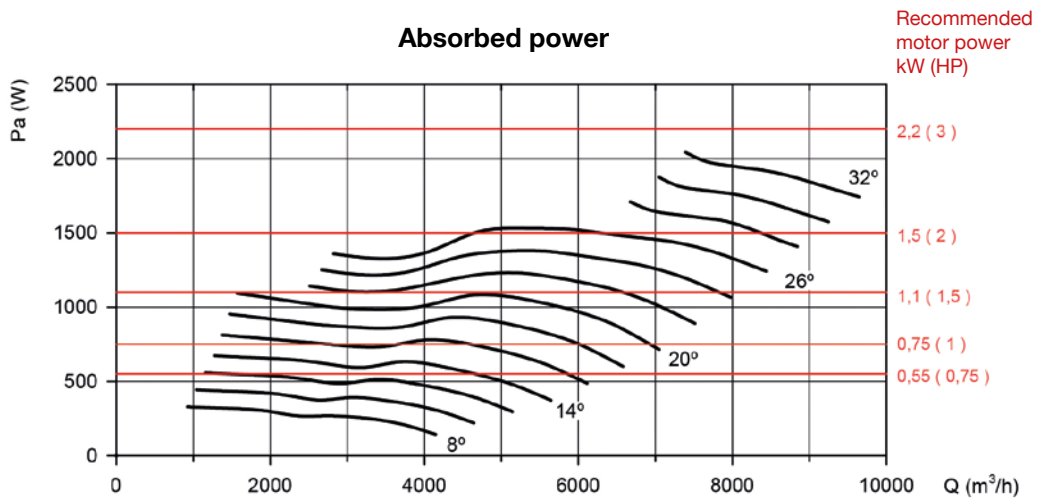

Characteristic curves

Q= Flow rate in m³/h, m³/s and cfm Pe= Static pressure in mm H₂O, Pa and inwg

Impeller diameter in cm: 40

Number of motor poles: 4

Number of blades: 6

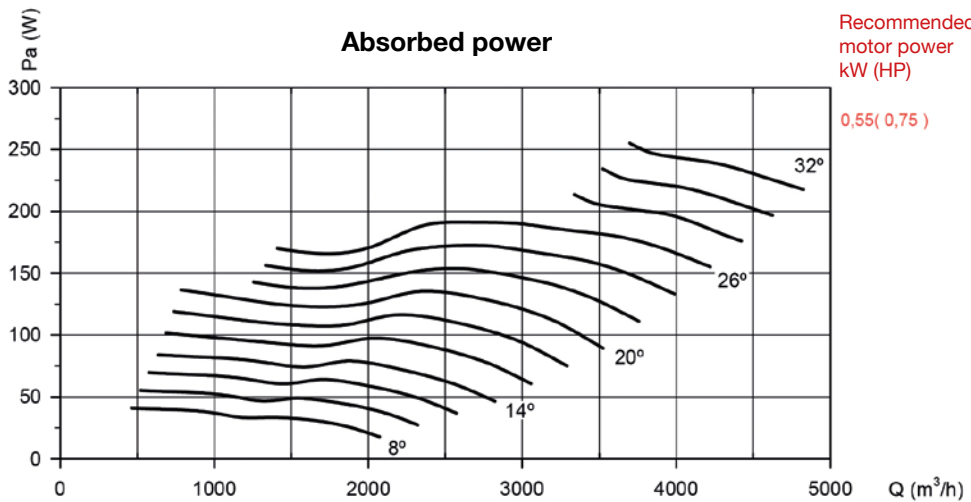
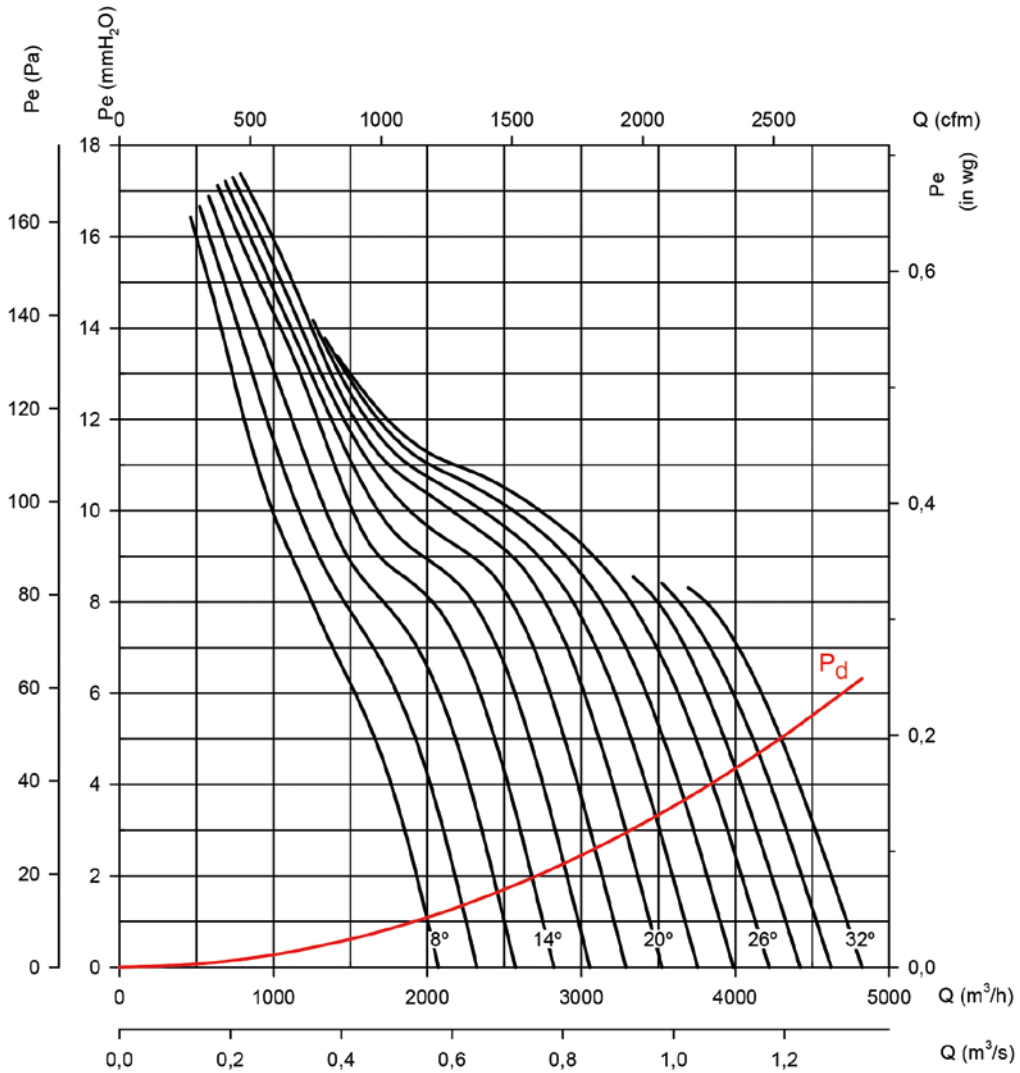

Characteristic curves

Q= Flow rate in m³/h, m³/s and cfm

Pe= Static pressure in mm H₂O, Pa and inwg

Impeller diameter in cm: 40

Number of motor poles: 6

Number of blades: 6

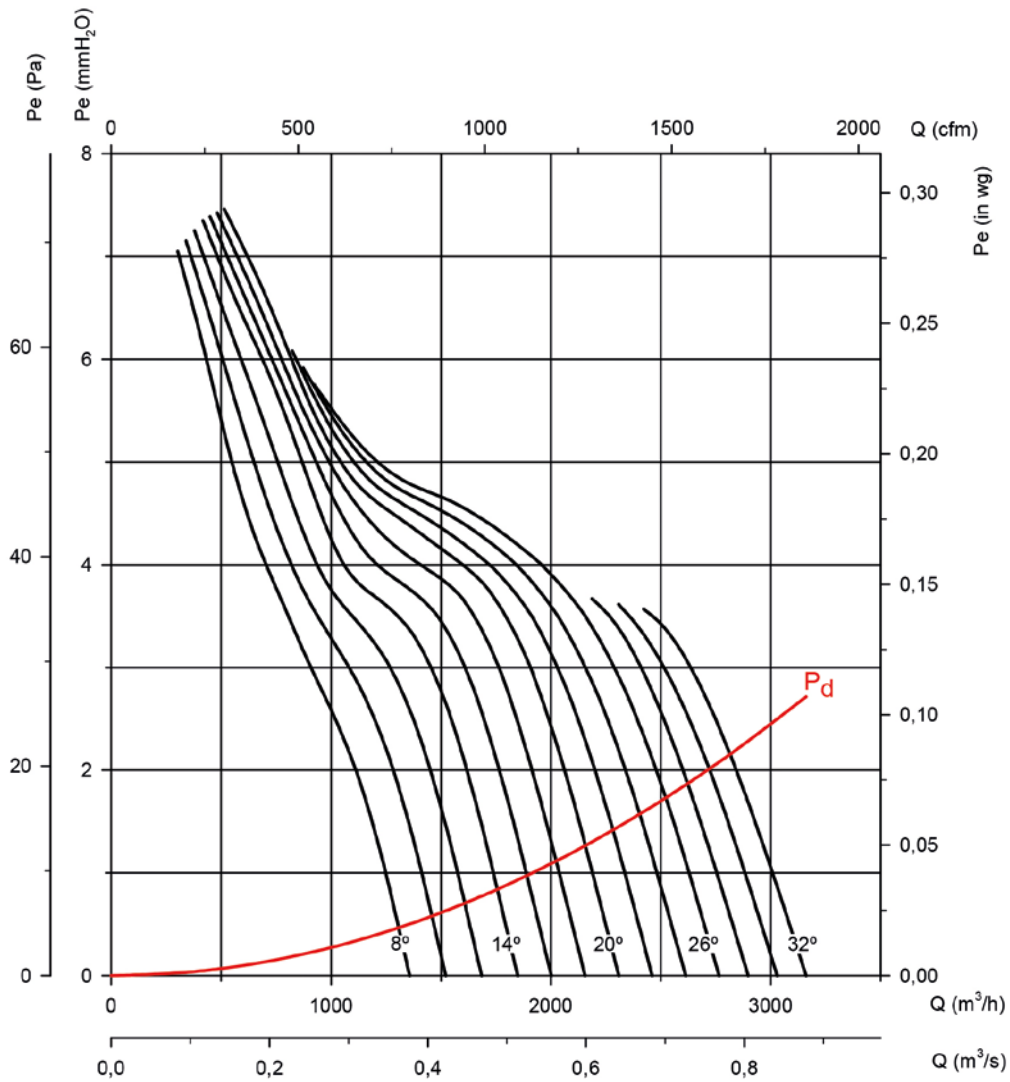

Absorbed power

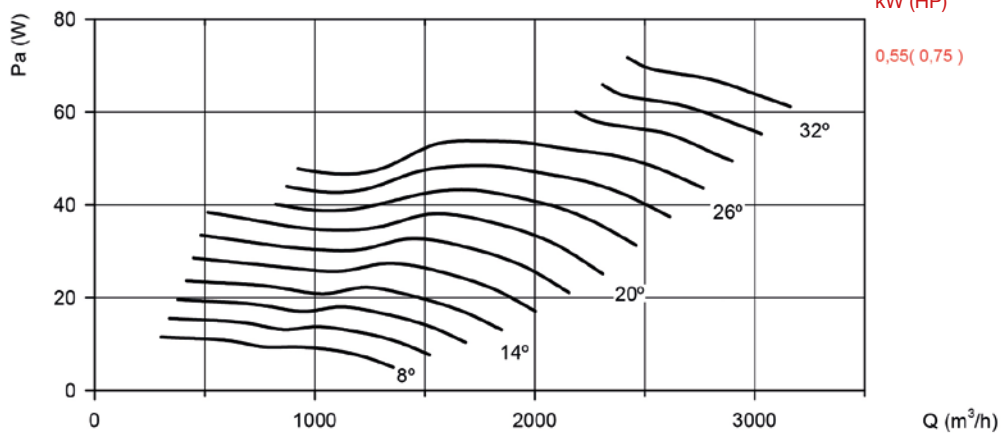

Characteristic curves

Q= Flow rate in m³/h, m³/s and cfm Pe= Static pressure in mm H₂O, Pa and inwg

Impeller diameter in cm: 45

Number of motor poles: 2

Number of blades: 6

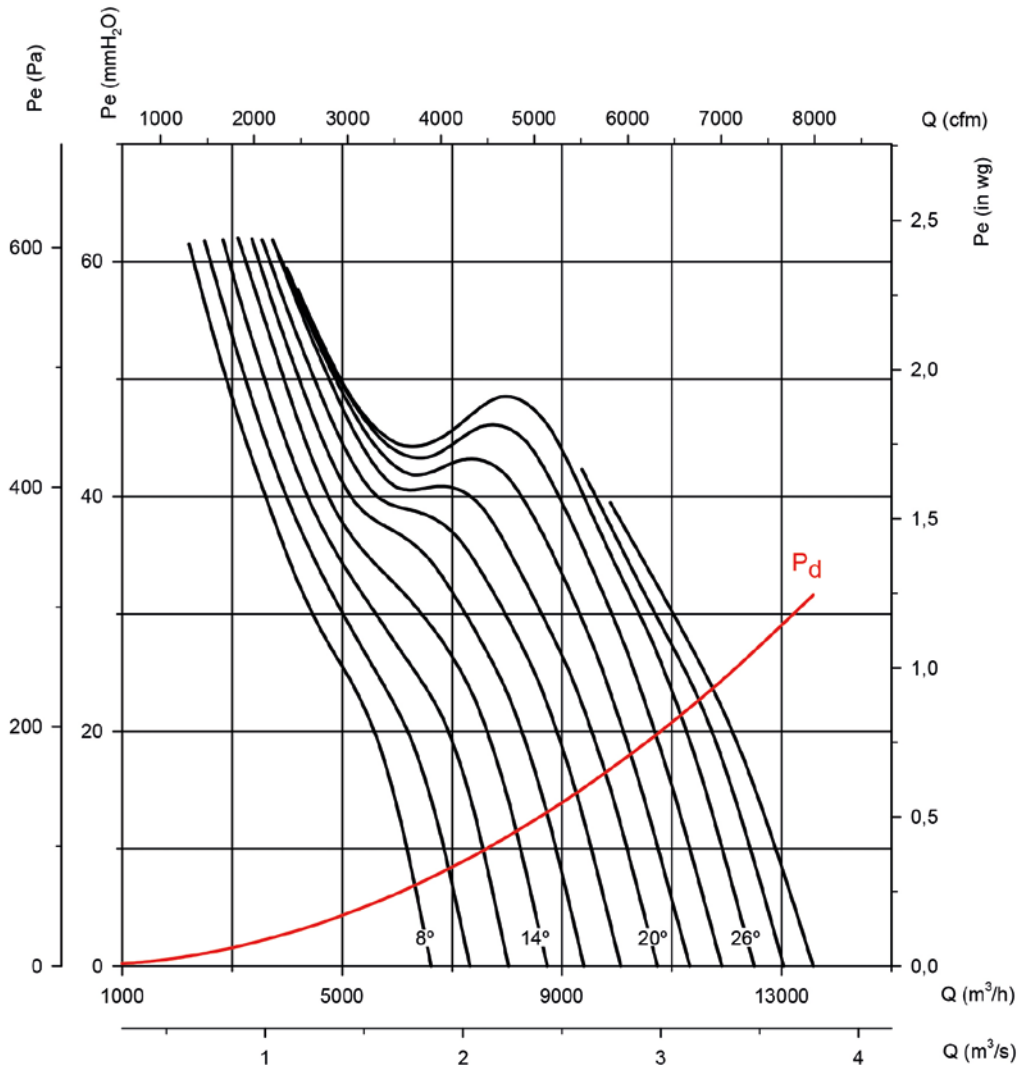

Absorbed power

Recommended motor power kW (HP)

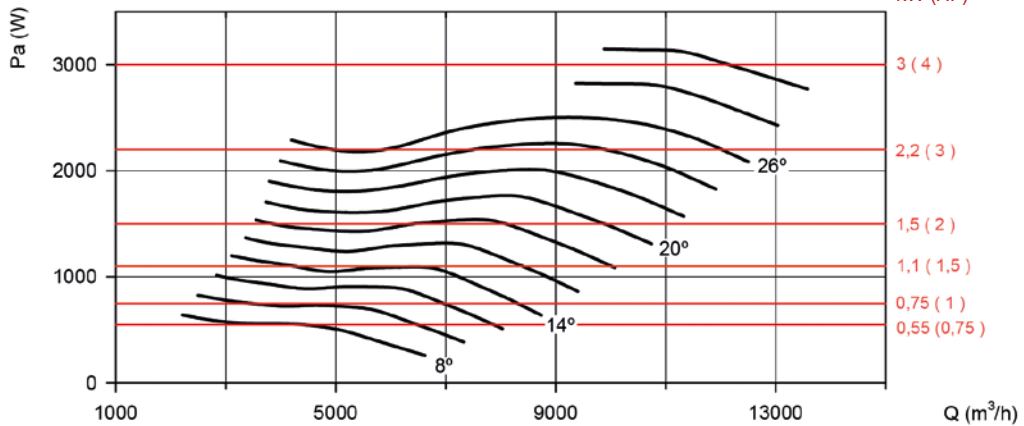

Characteristic curves

Q= Flow rate in m³/h, m³/s and cfm

Pe= Static pressure in mm H₂O, Pa and inwg

Impeller diameter in cm: 45

Number of motor poles: 4

Number of blades: 6

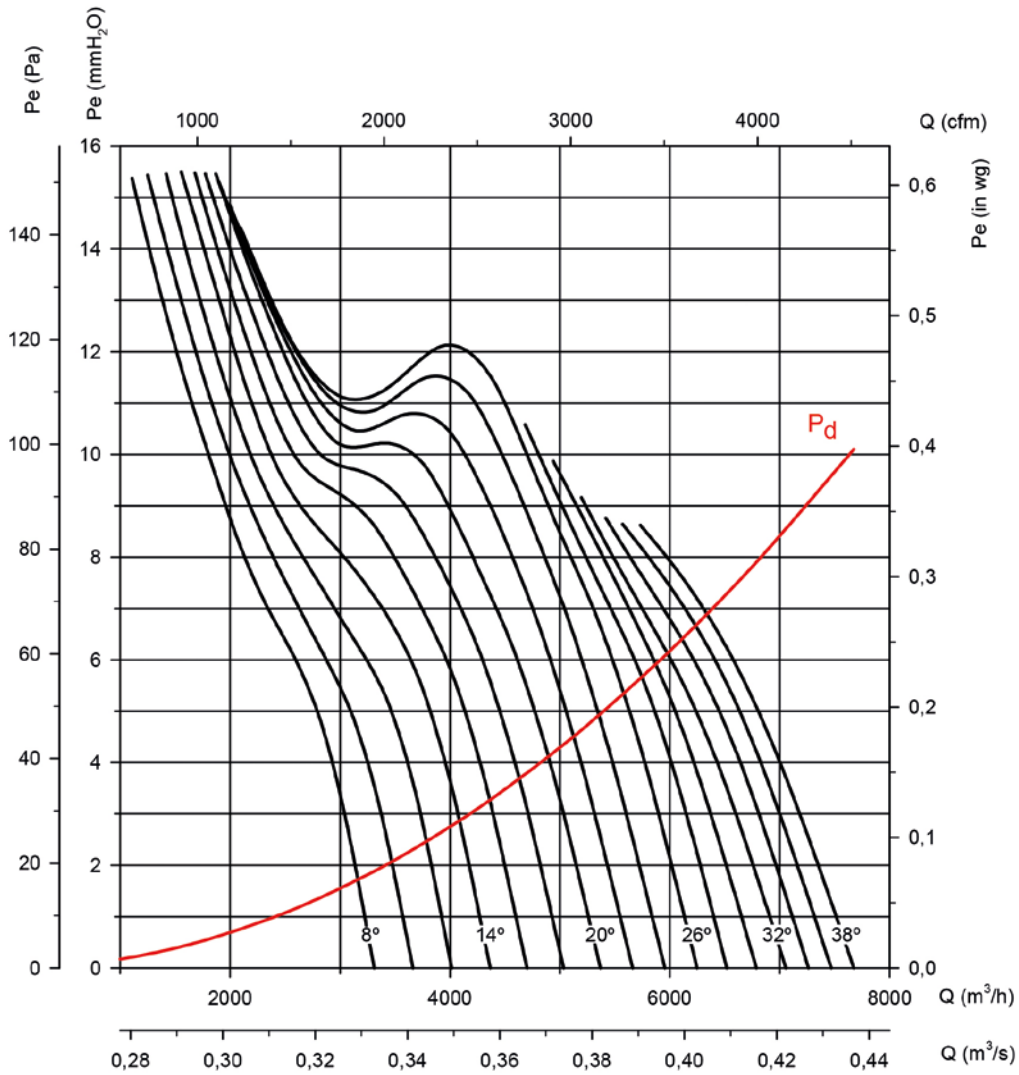

Absorbed power

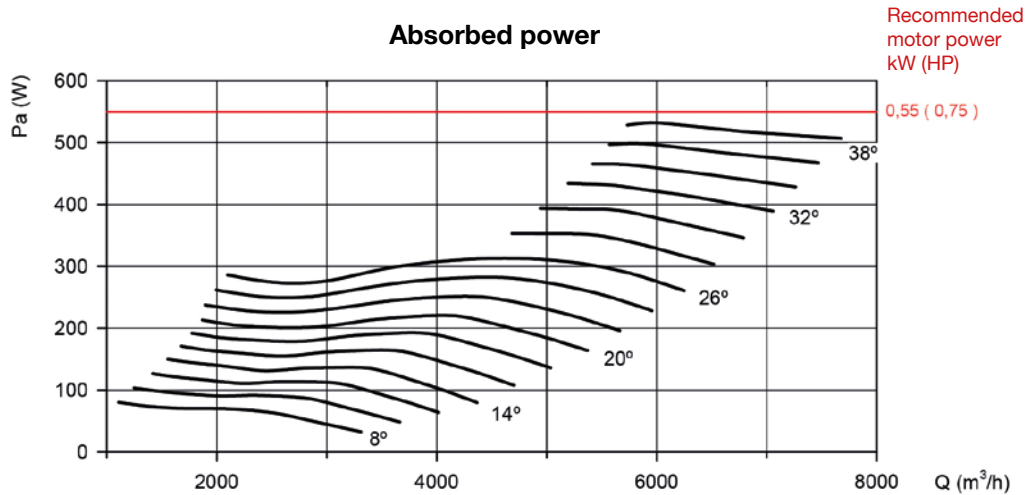

Characteristic curves

Q= Flow rate in m³/h, m³/s and cfm Pe= Static pressure in mm H₂O, Pa and inwg

Impeller diameter in cm: 45

Number of motor poles: 6

Number of blades: 6

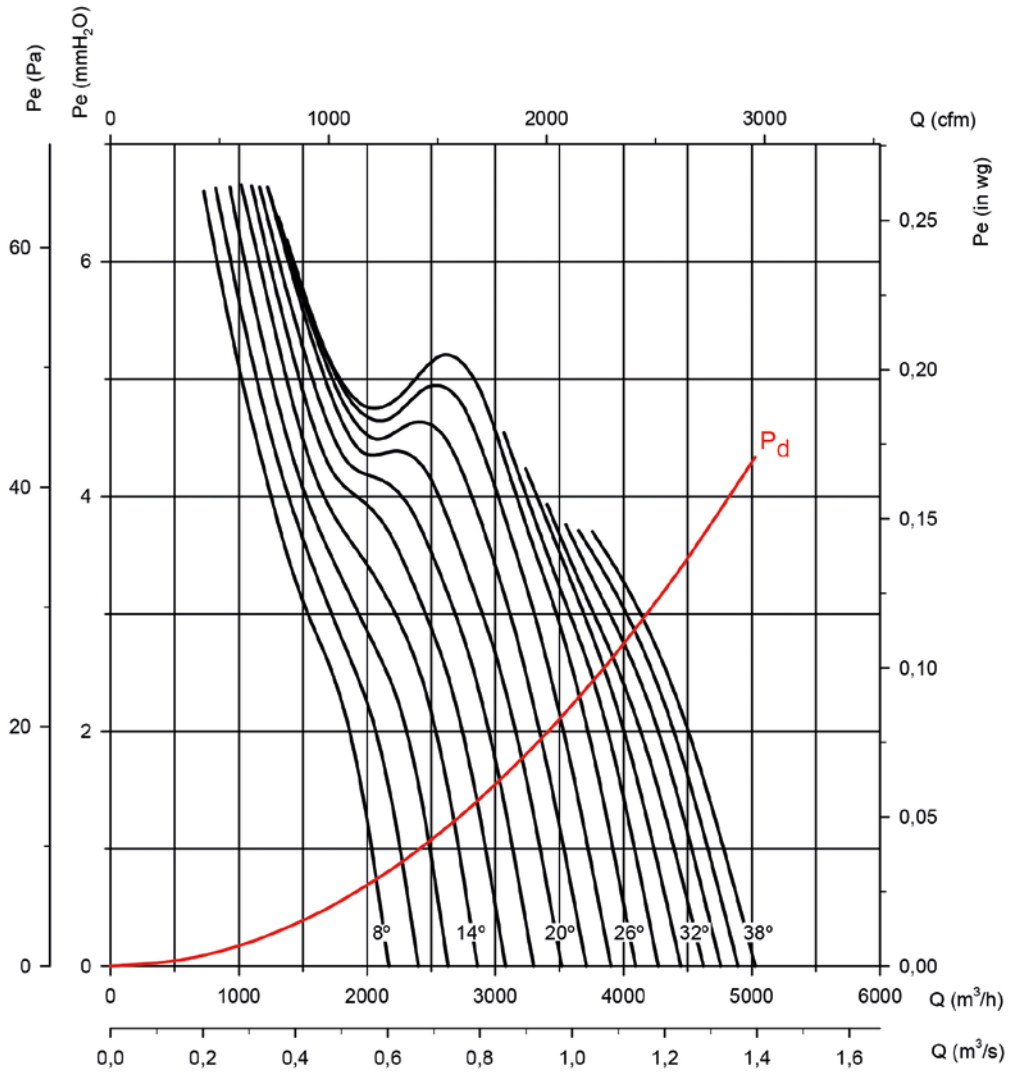

Absorbed power

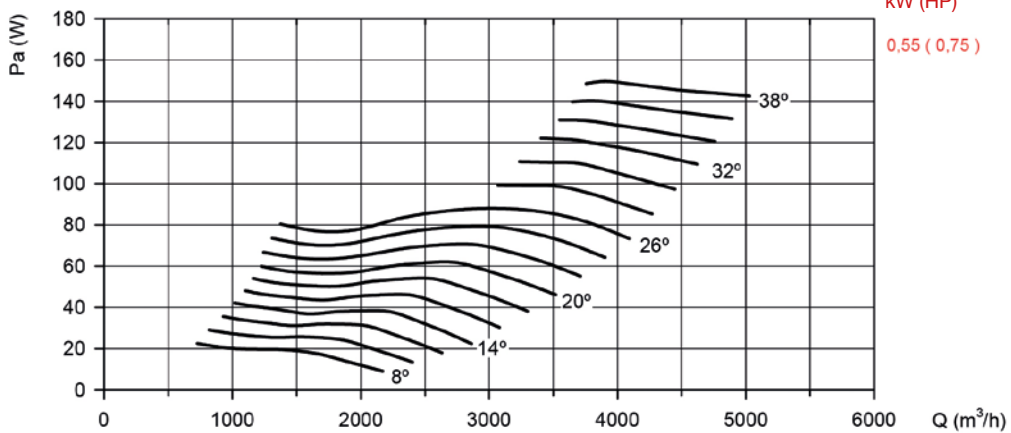

Recommended motor power kW (HP)
0.55 (0.75)

Characteristic curves

Q= Flow rate in m³/h, m³/s and cfm Pe= Static pressure in mm H₂O, Pa and inwg

Impeller diameter in cm: 50

Number of motor poles: 4

Number of blades: 6

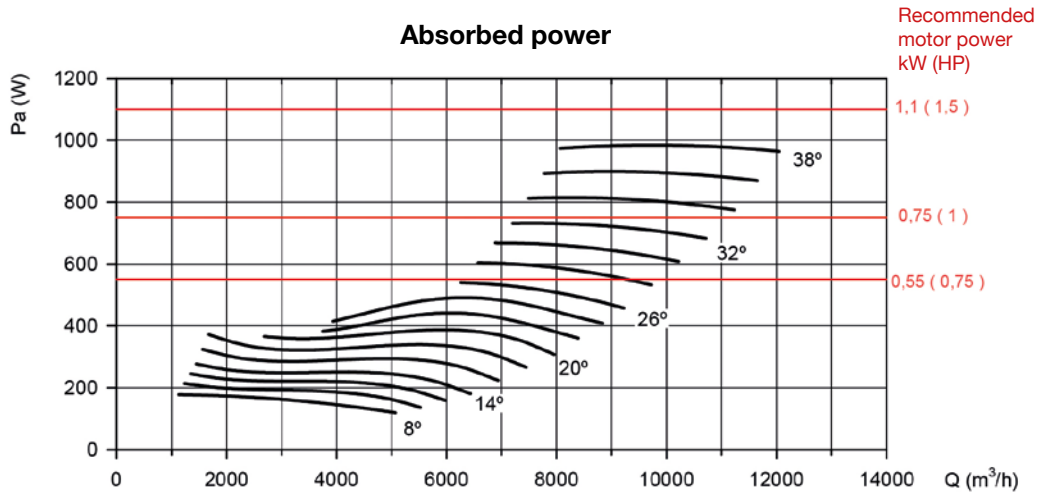
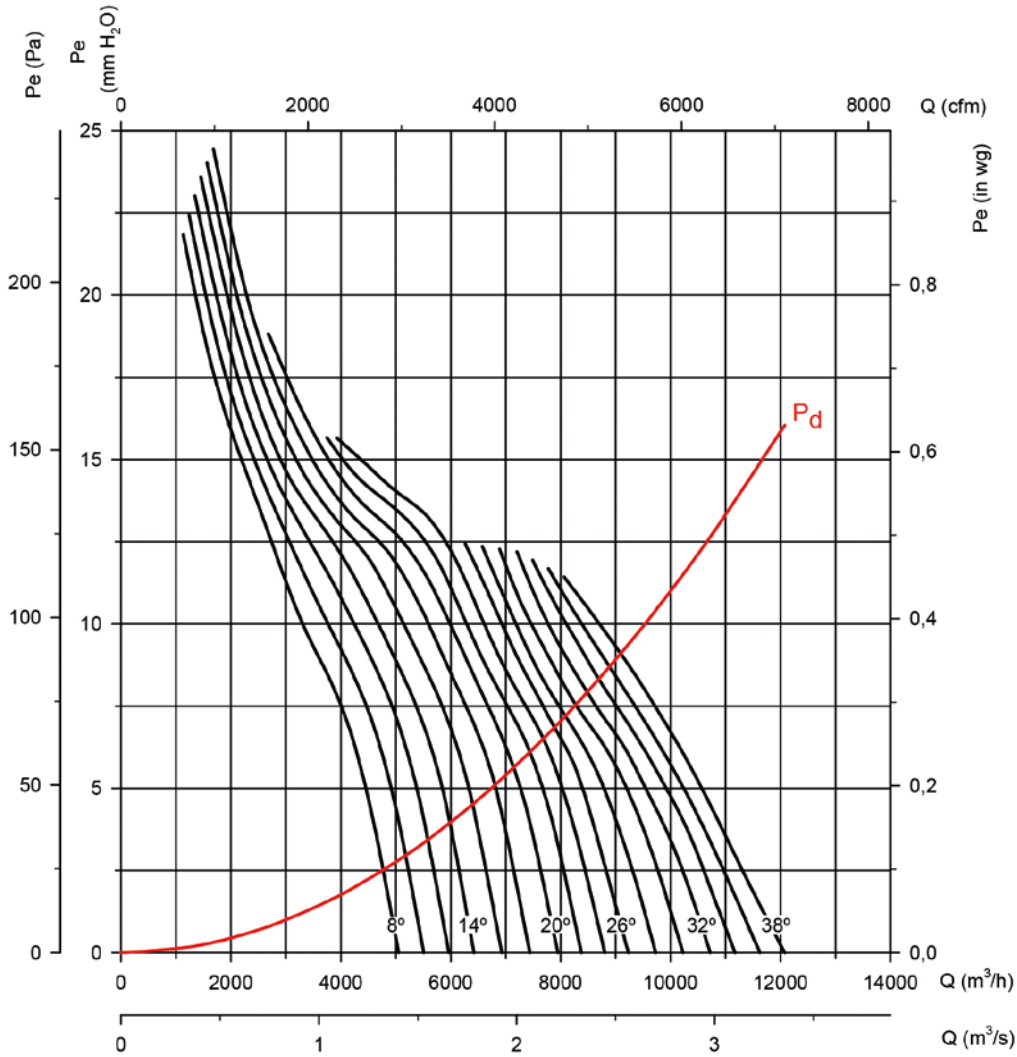

Characteristic curves

Q= Flow rate in m³/h, m³/s and cfm Pe= Static pressure in mm H₂O, Pa and inwg

Impeller diameter in cm: 50

Number of motor poles: 6

Number of blades: 6

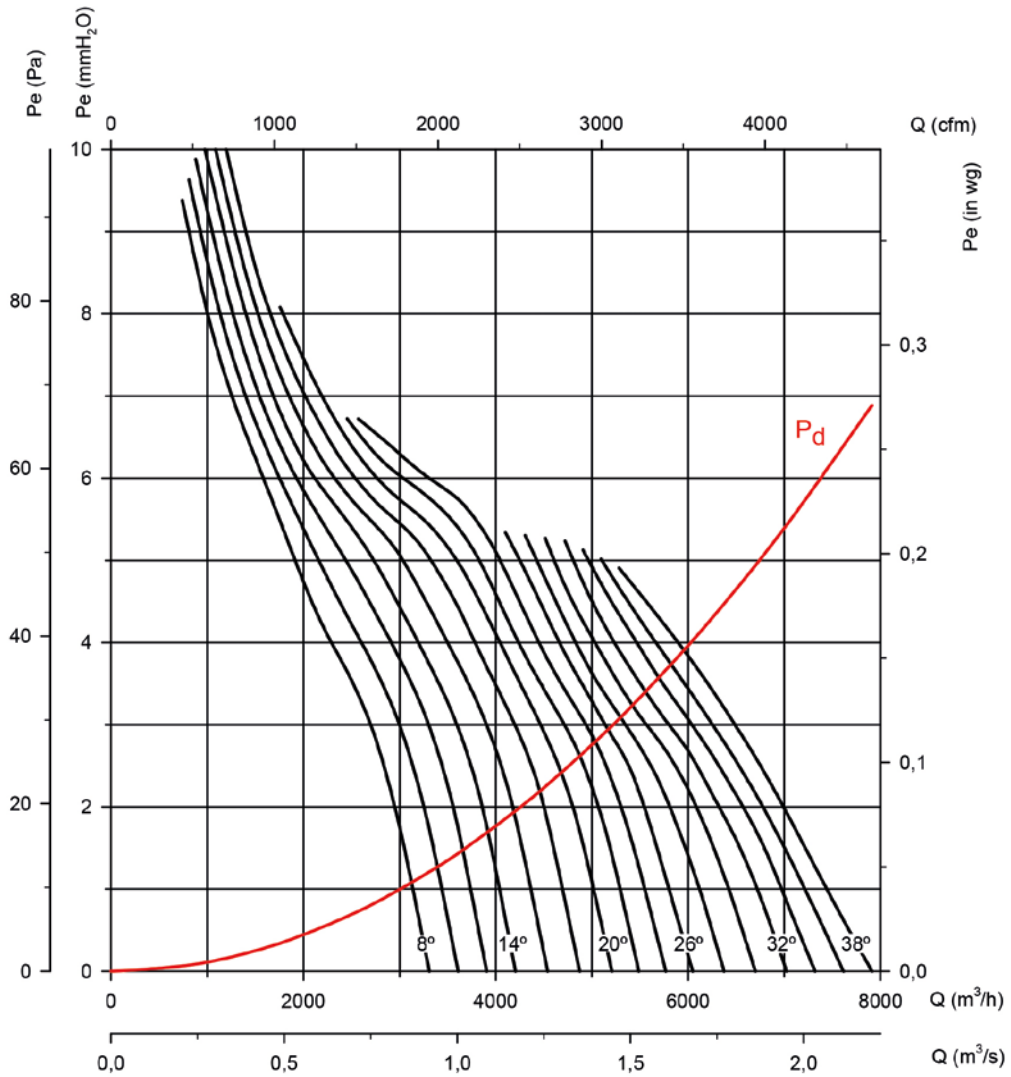

Absorbed power

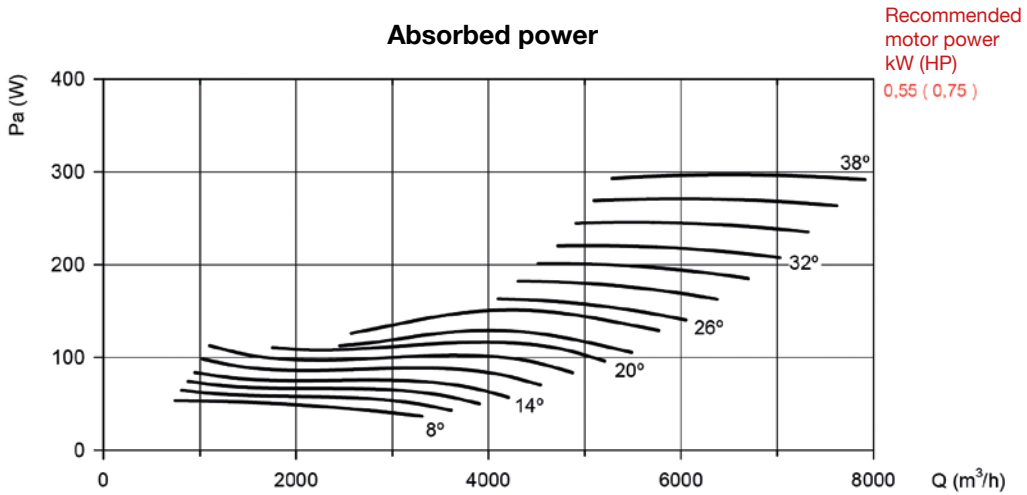

Characteristic curves

Q= Flow rate in m³/h, m³/s and cfm Pe= Static pressure in mm H₂O, Pa and inwg

Impeller diameter in cm: 56

Number of motor poles: 4

Number of blades: 6

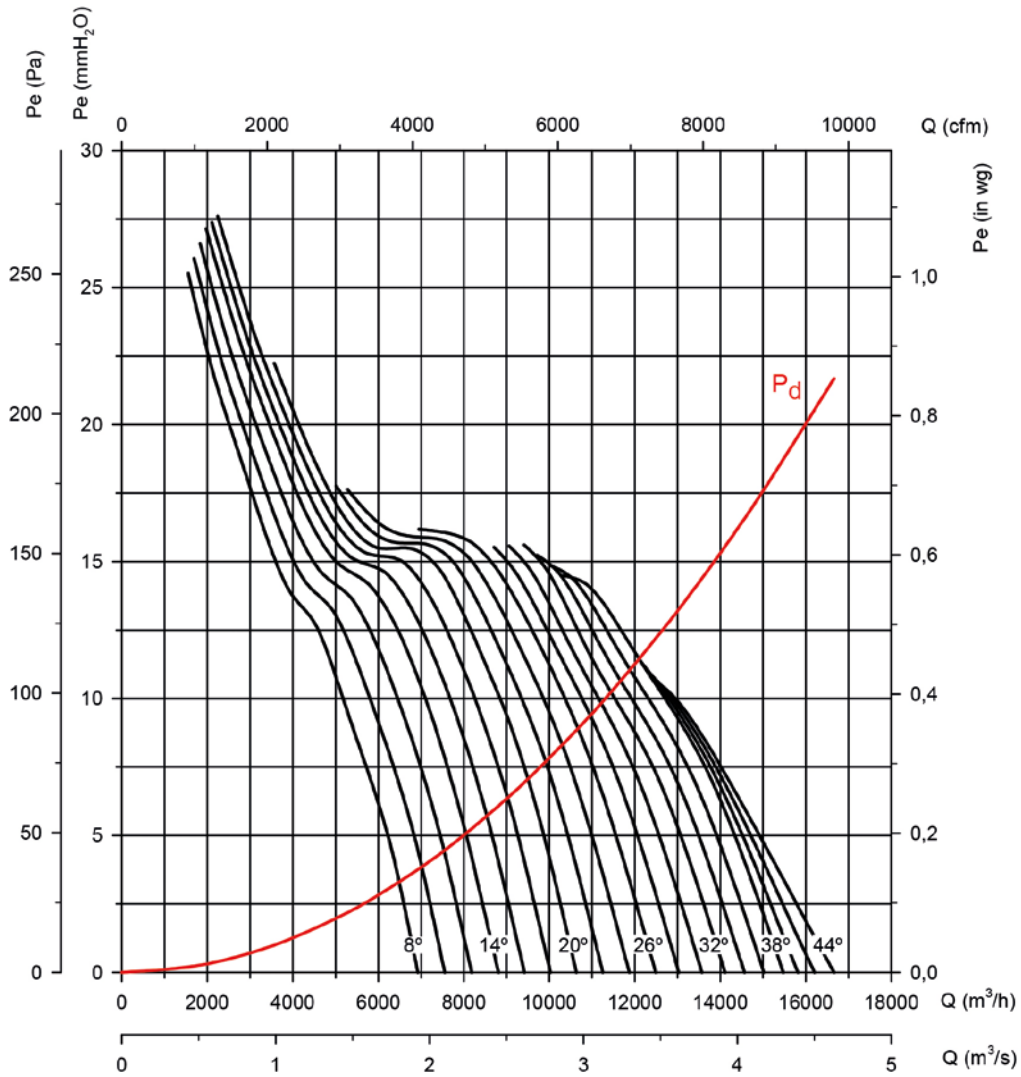

Absorbed power

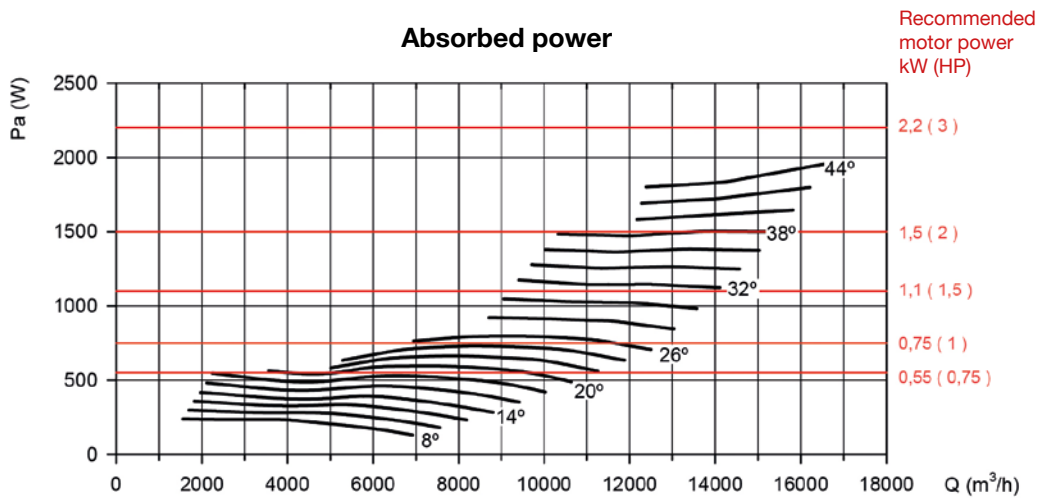

Characteristic curves

Q= Flow rate in m³/h, m³/s and cfm

Pe= Static pressure in mm H₂O, Pa and inwg

Impeller diameter in cm: 56

Number of motor poles: 6

Number of blades: 6

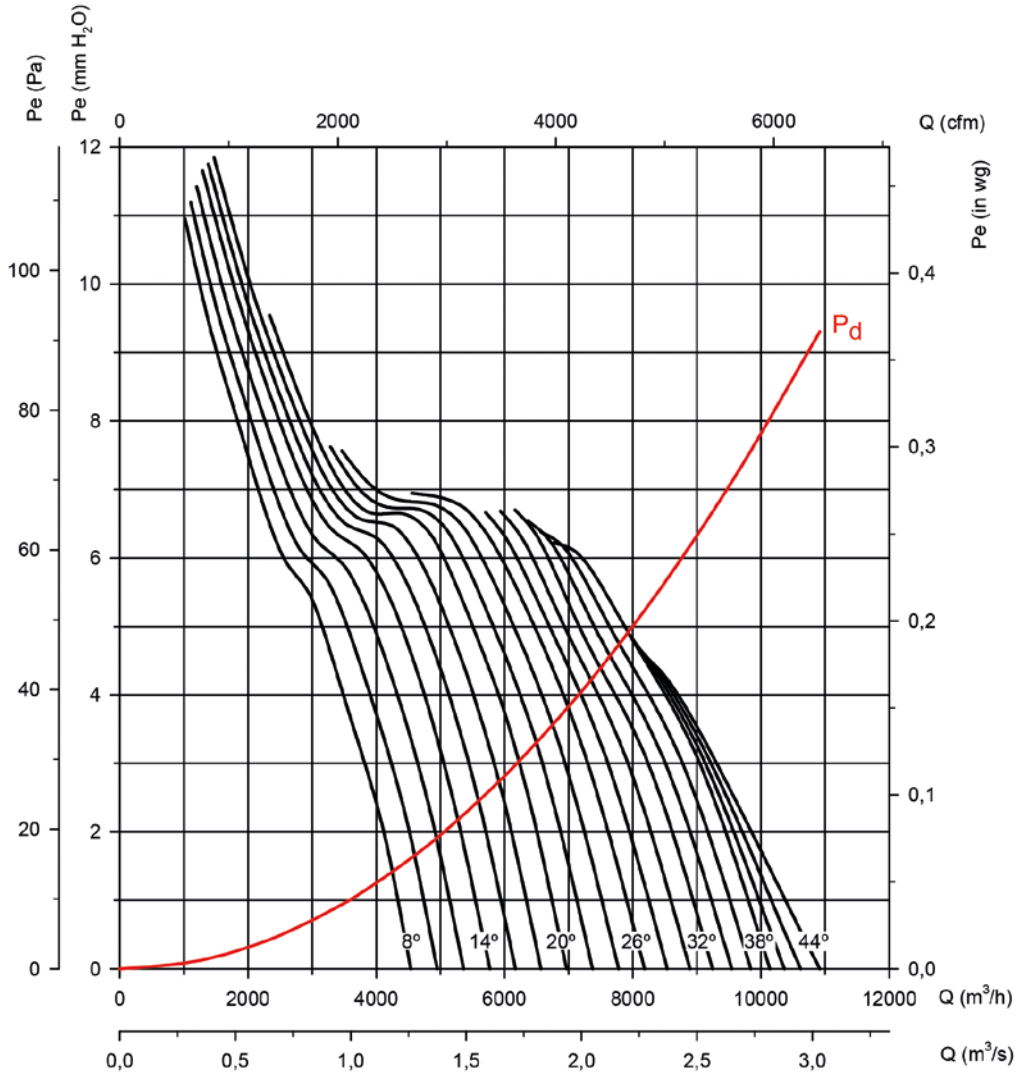

Absorbed power

Recommended motor power kW (HP)

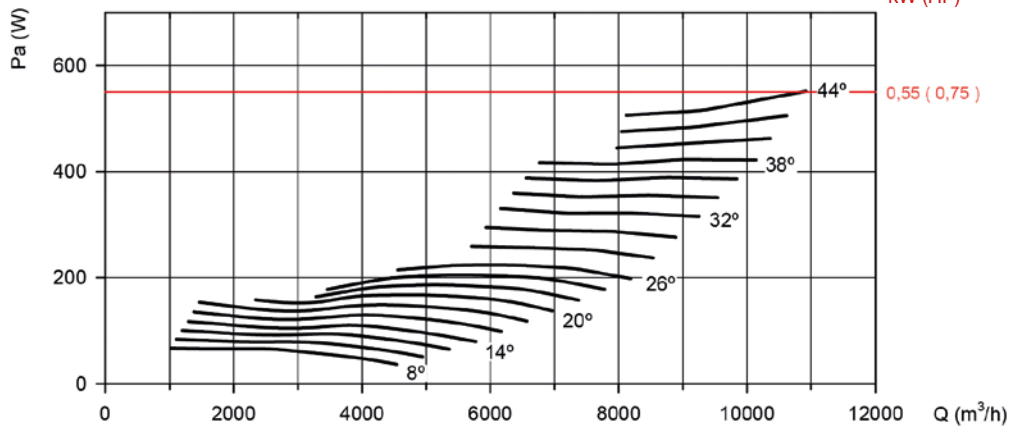

Characteristic curves

Q= Flow rate in m³/h, m³/s and cfm

Pe= Static pressure in mm H₂O, Pa and inwg

Impeller diameter in cm: 63

Number of motor poles: 4

Number of blades: 6

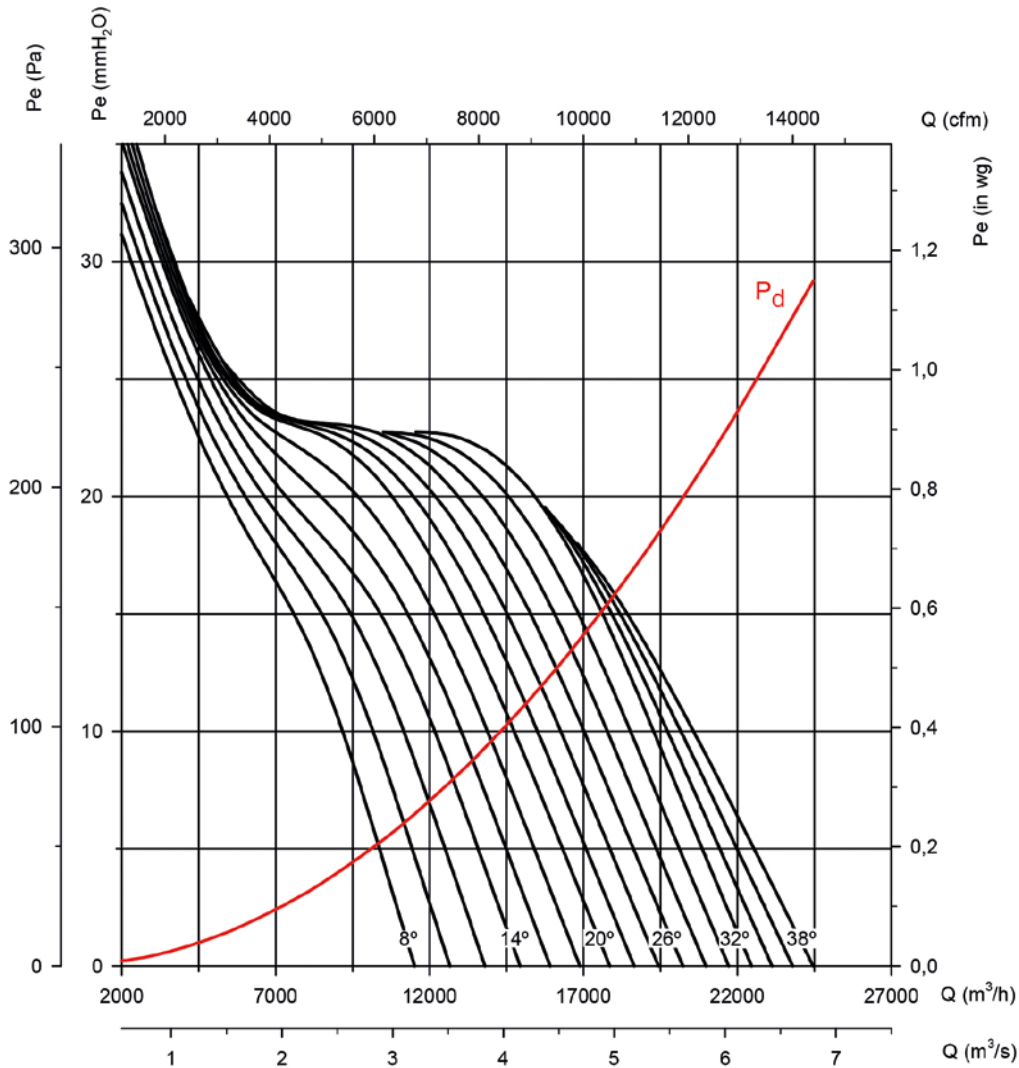

Absorbed power

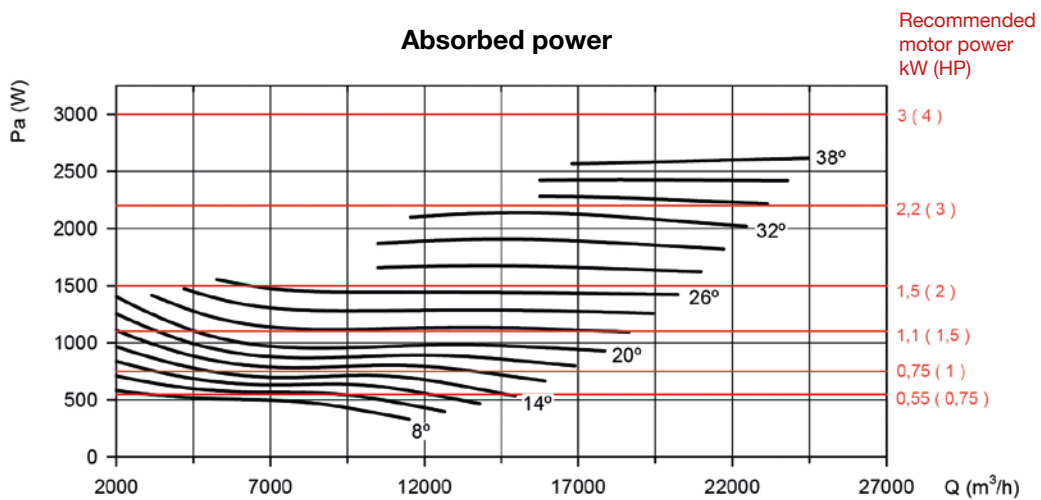

Characteristic curves

Q= Flow rate in m³/h, m³/s and cfm Pe= Static pressure in mm H₂O, Pa and inwg

Impeller diameter in cm: 63

Number of motor poles: 6

Number of blades: 6

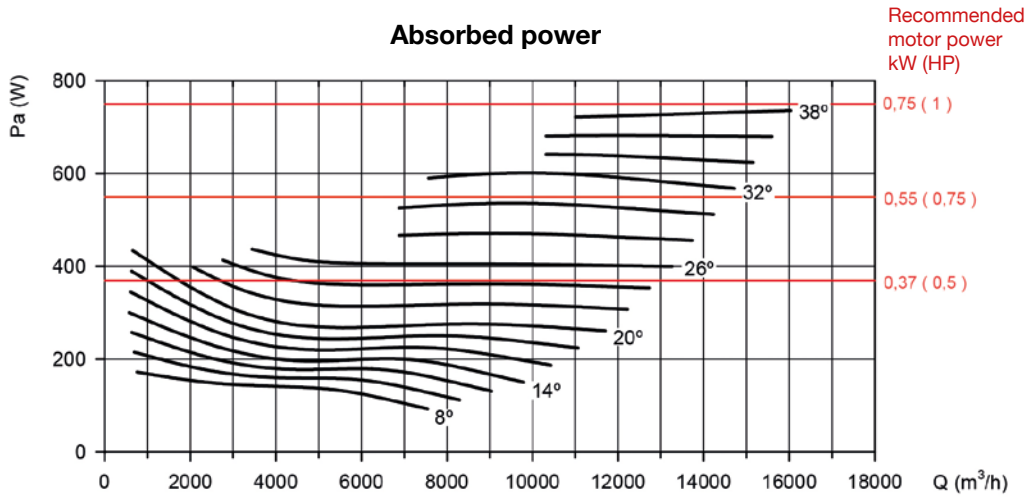
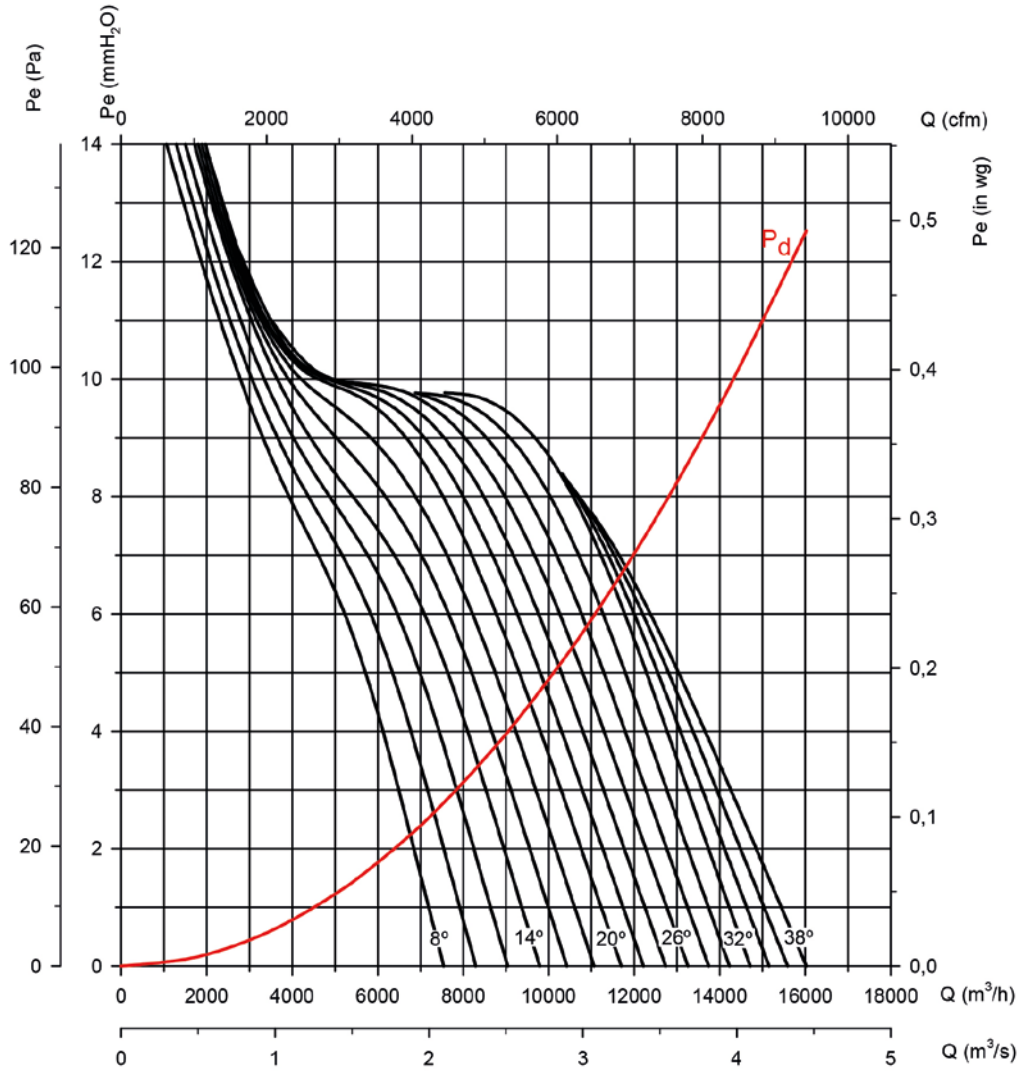

Characteristic curves

Q= Flow rate in m³/h, m³/s and cfm Pe= Static pressure in mm H₂O, Pa and inwg

Impeller diameter in cm: 71

Number of motor poles: 4

Number of blades: 6

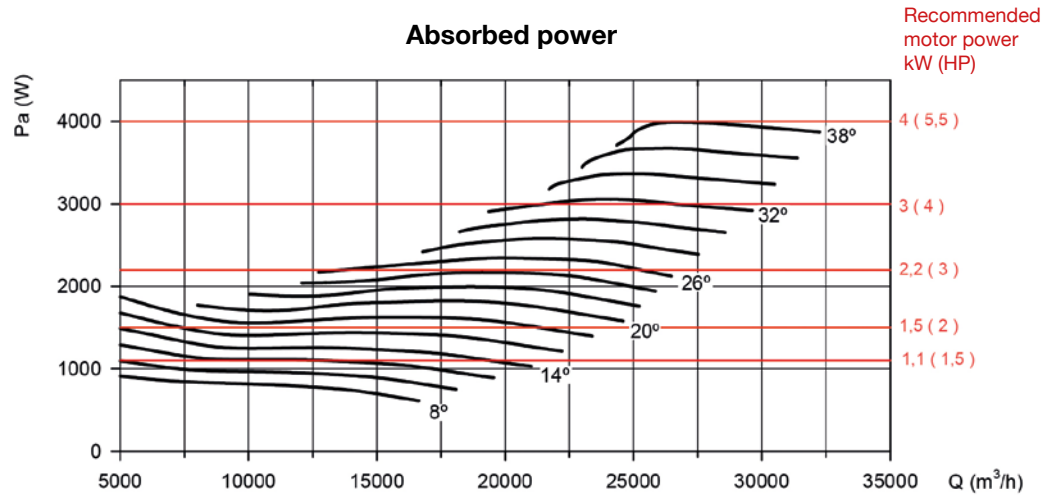
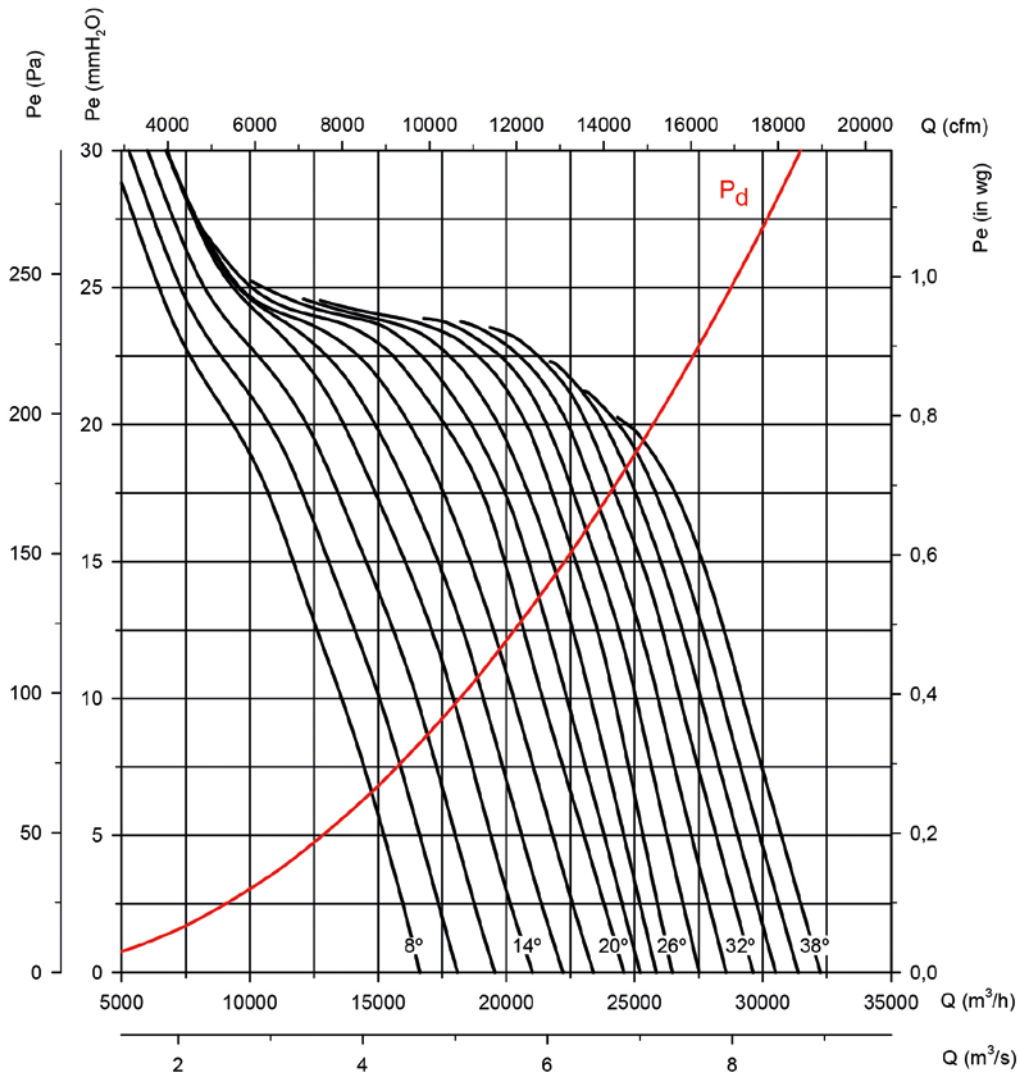

Characteristic curves

Q= Flow rate in m³/h, m³/s and cfm Pe= Static pressure in mm H₂O, Pa and inwg

Impeller diameter in cm: 71

Number of motor poles: 6

Number of blades: 6

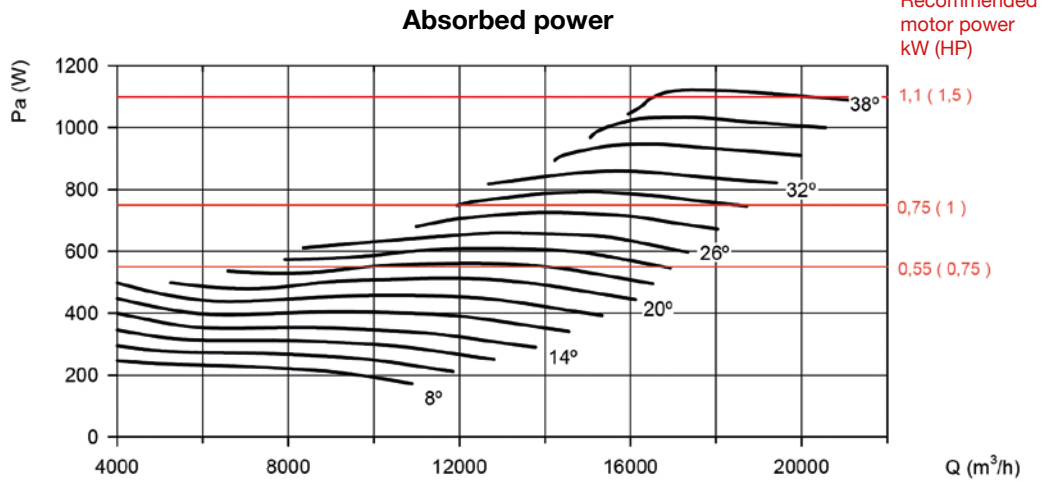
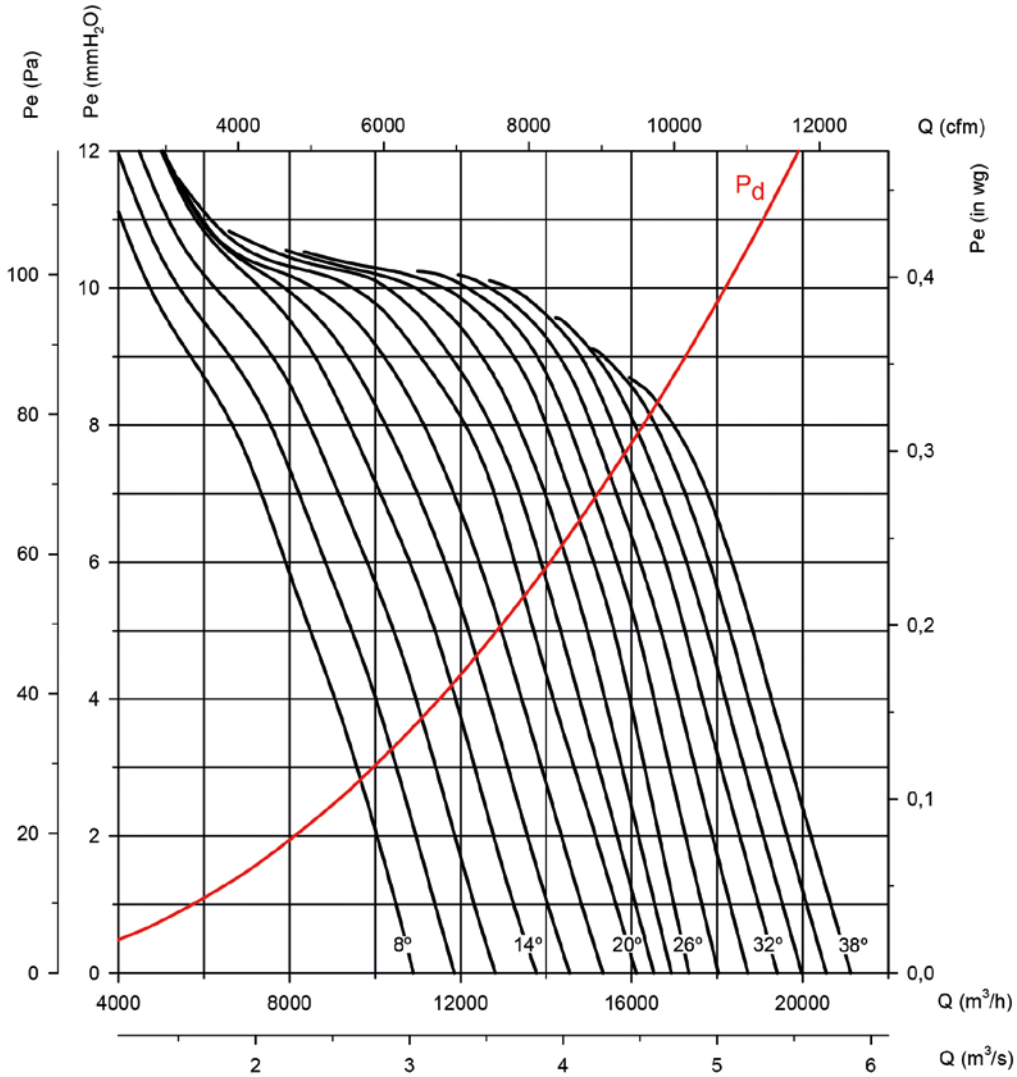

Characteristic curves

Q= Flow rate in m³/h, m³/s and cfm

Pe= Static pressure in mm H₂O, Pa and inwg

Impeller diameter in cm: 80

Number of motor poles: 4

Number of blades: 6

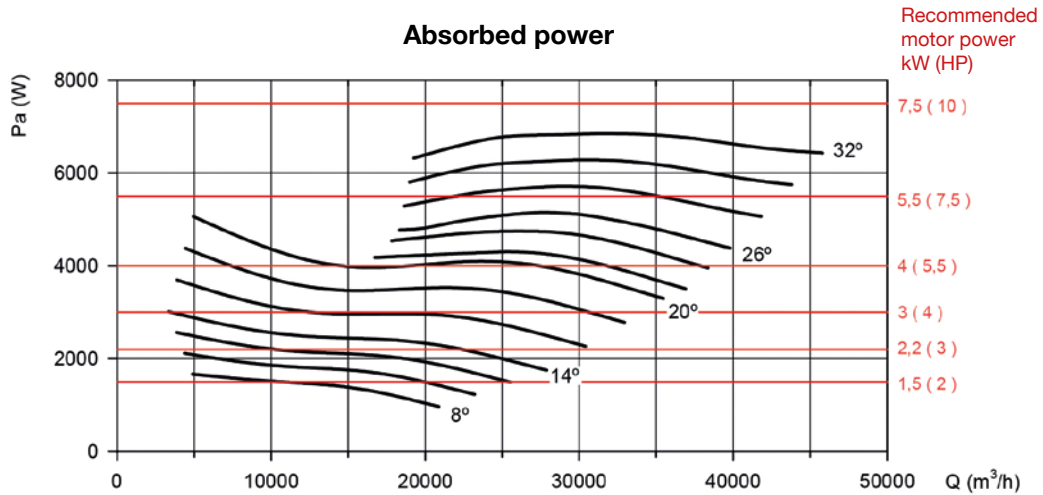
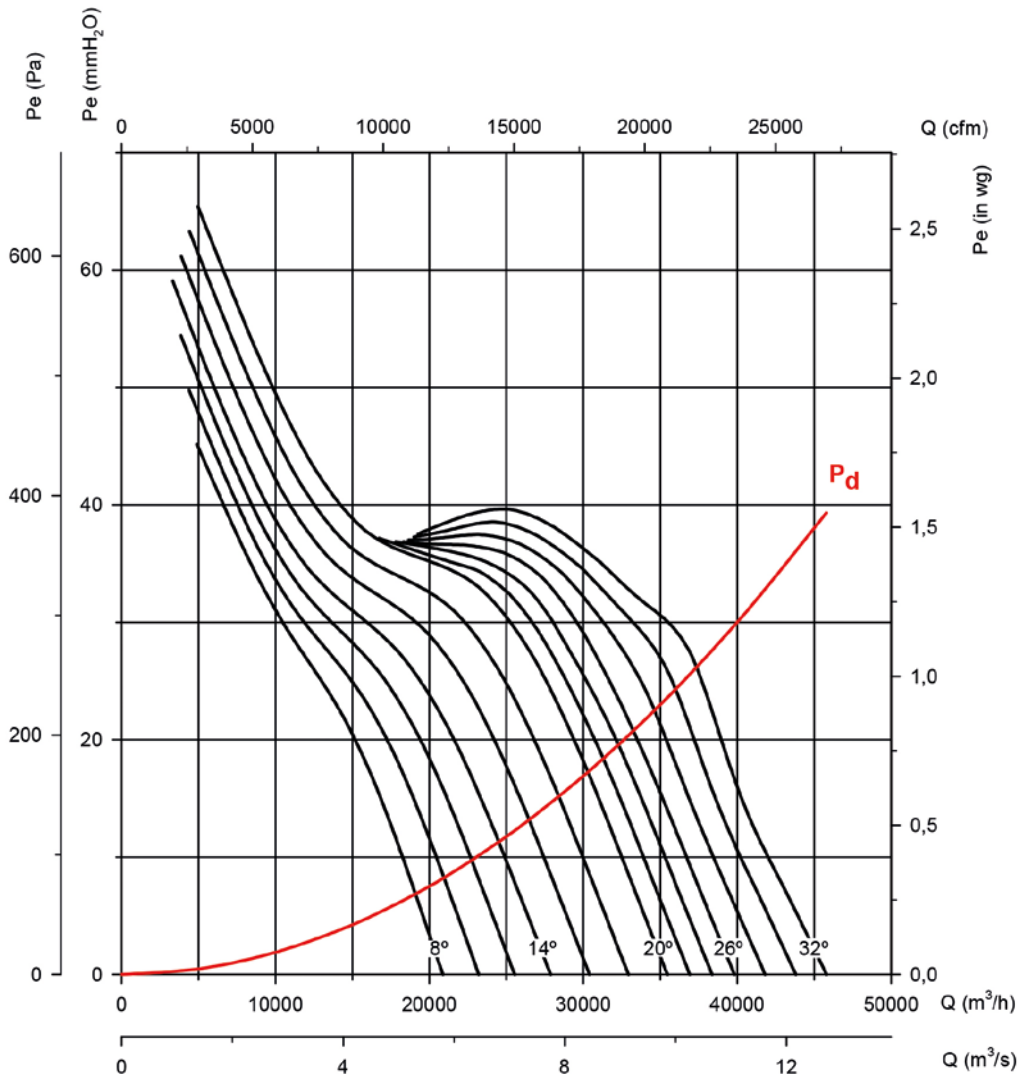

Characteristic curves

Q= Flow rate in m³/h, m³/s and cfm Pe= Static pressure in mm H₂O, Pa and inwg

Impeller diameter in cm: 80

Number of motor poles: 6

Number of blades: 6

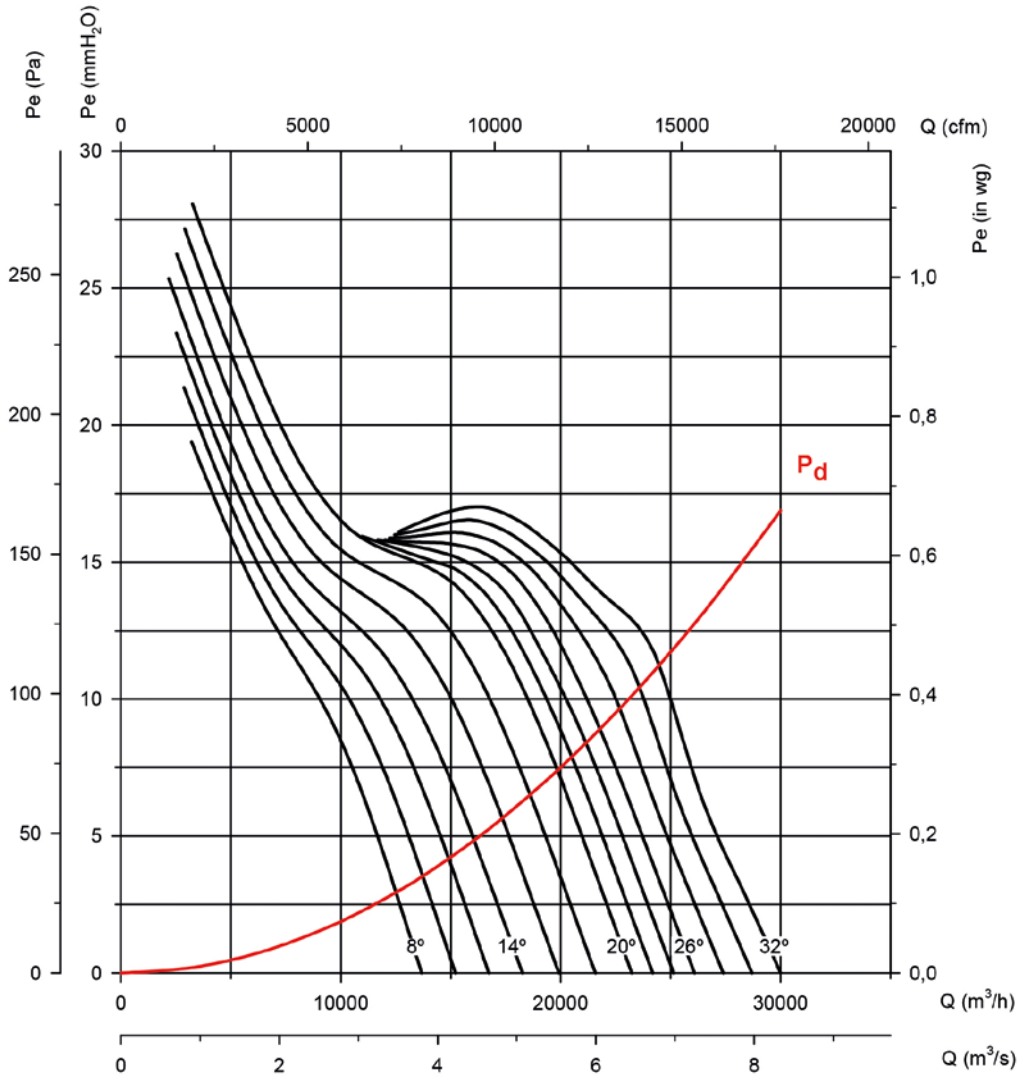

Absorbed power

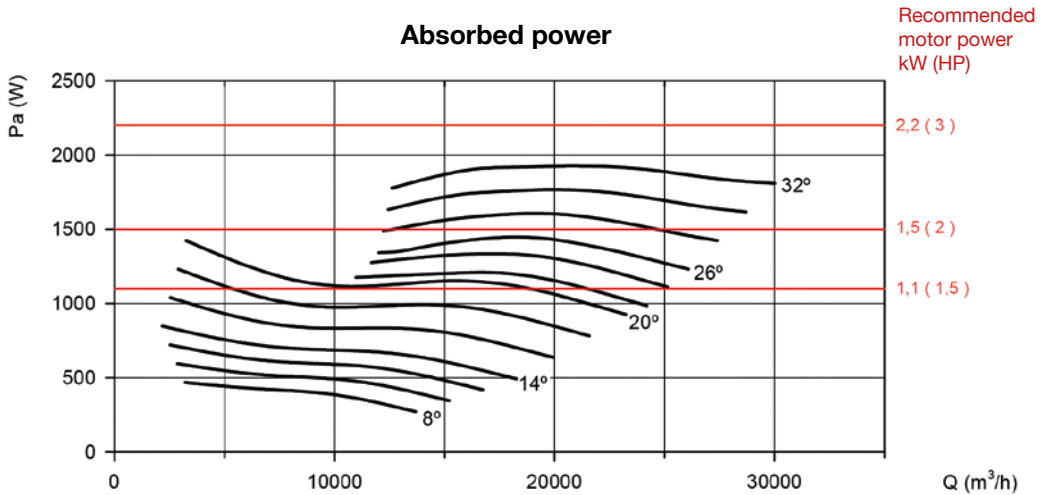

Characteristic curves

Q= Flow rate in m³/h, m³/s and cfm Pe= Static pressure in mm H₂O, Pa and inwg

Impeller diameter in cm: 80

Number of motor poles: 8

Number of blades: 6

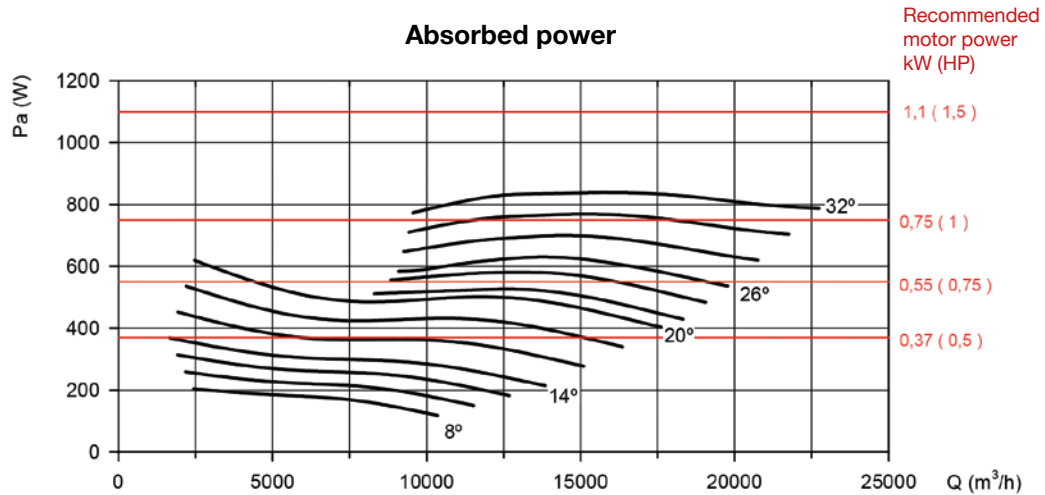
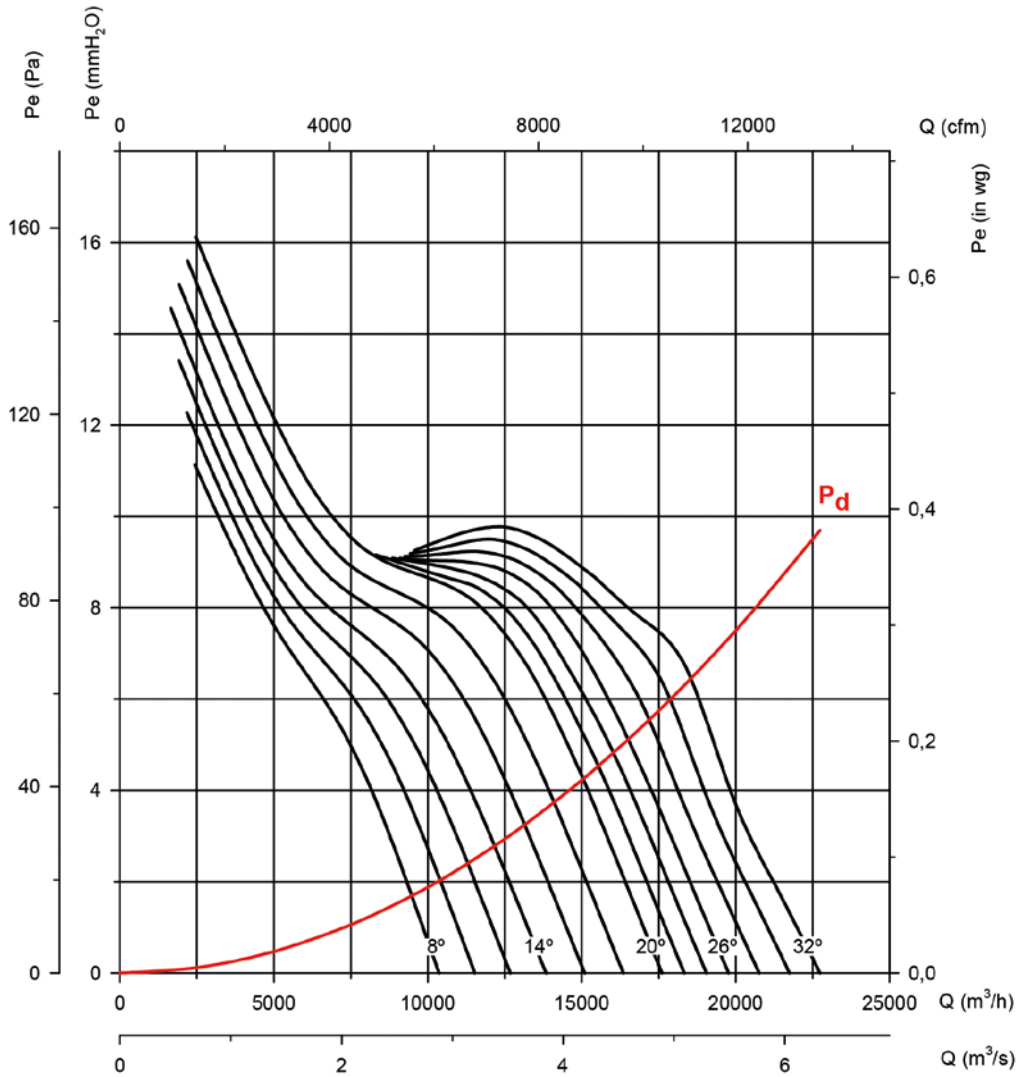

Characteristic curves

Q= Flow rate in m³/h, m³/s and cfm Pe= Static pressure in mm H₂O, Pa and inwg

Impeller diameter in cm: 90

Number of motor poles: 4

Number of blades: 6

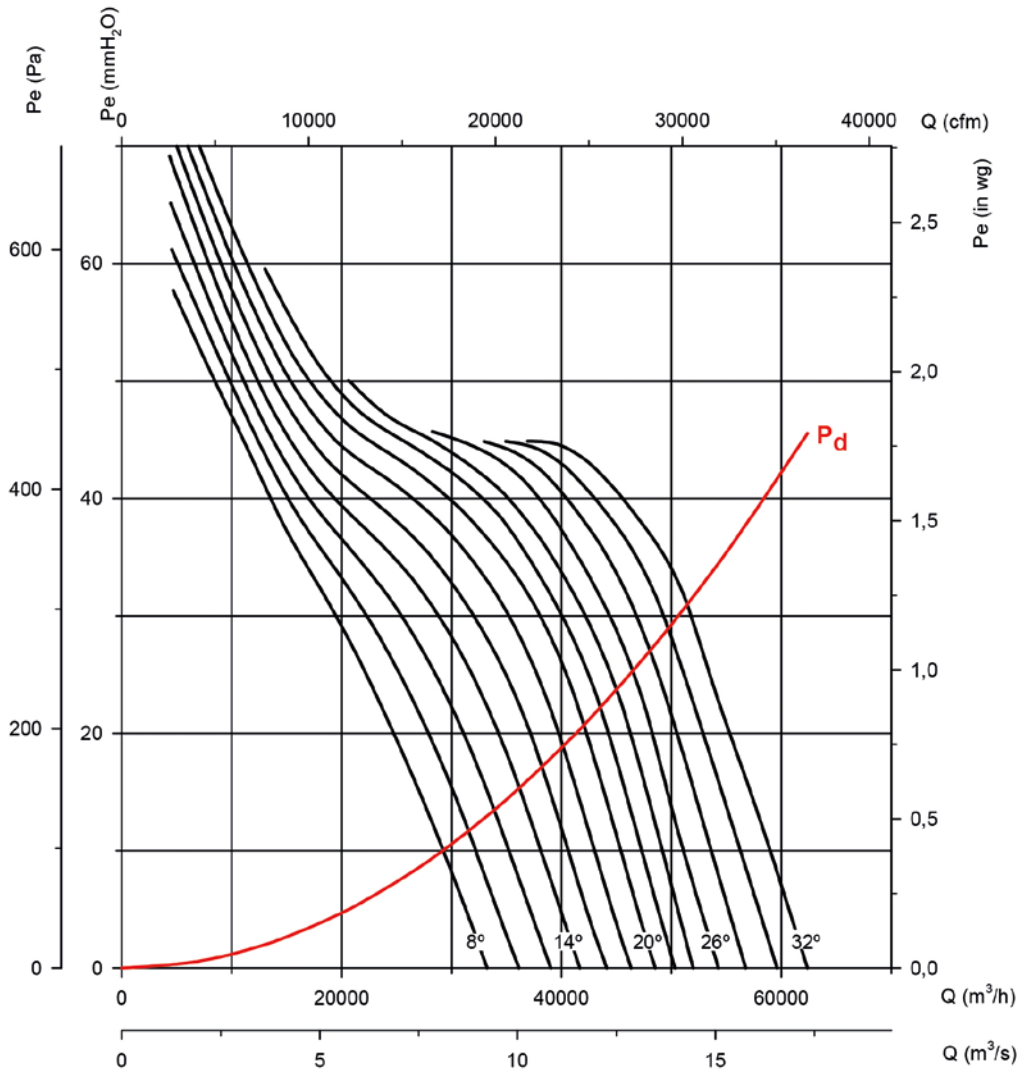

Absorbed power

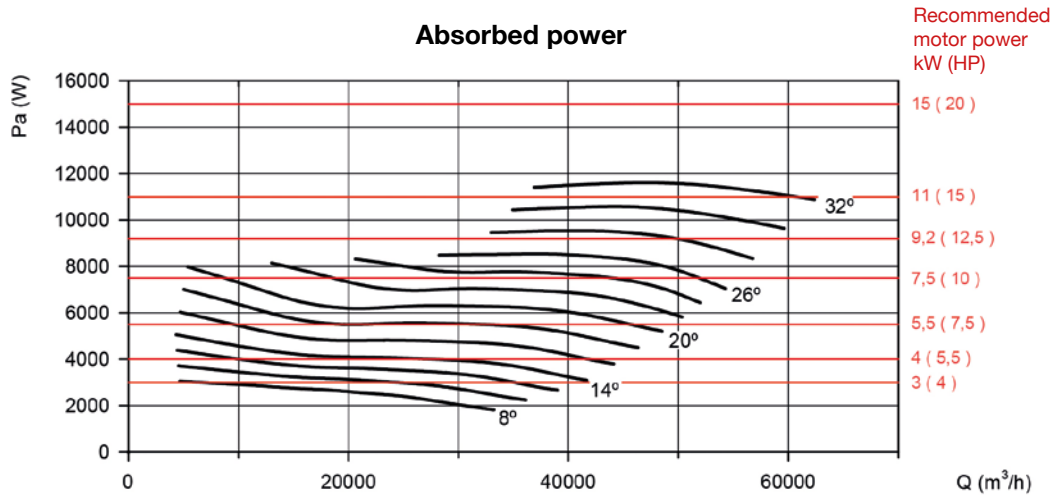

Characteristic curves

Q= Flow rate in m³/h, m³/s and cfm

Pe= Static pressure in mm H₂O, Pa and inwg

Impeller diameter in cm: 90

Number of motor poles: 6

Number of blades: 6

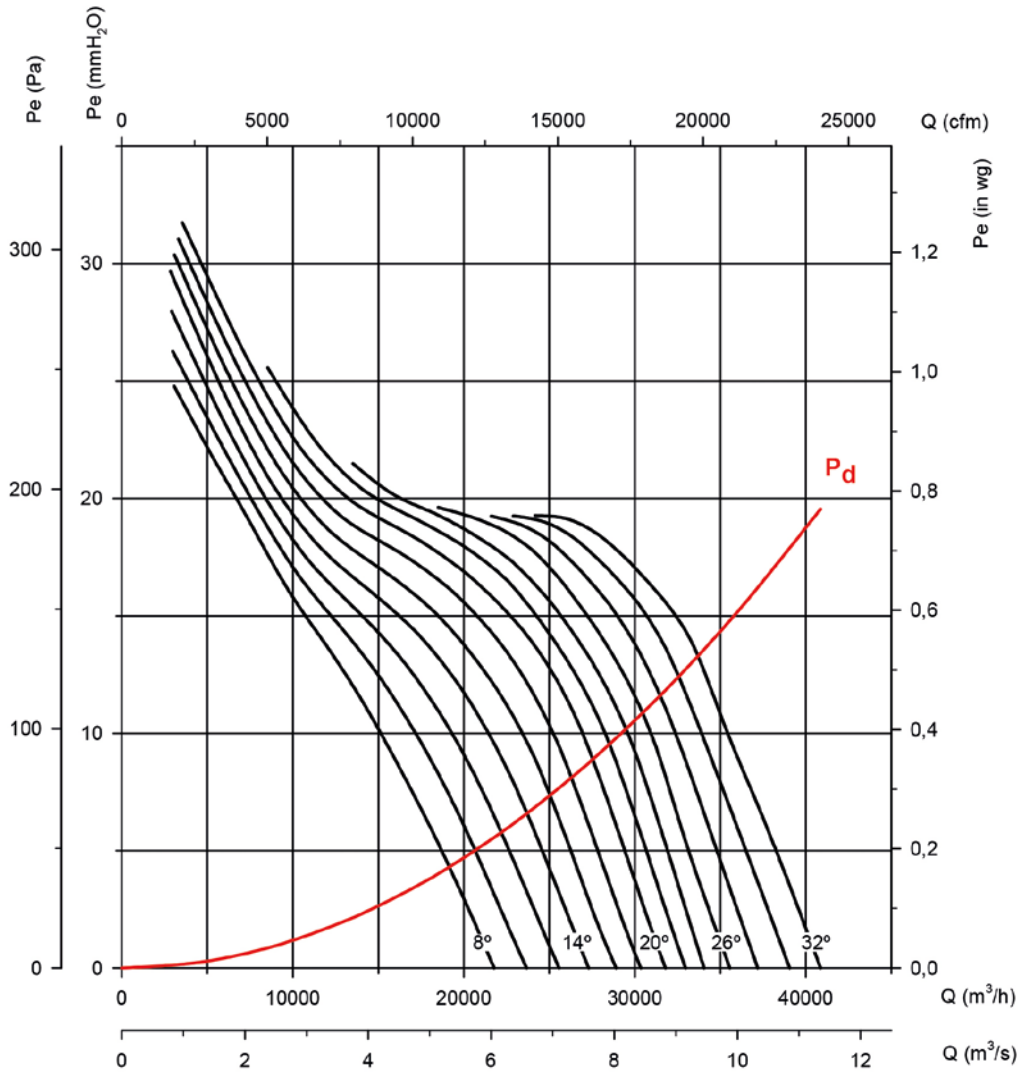

Absorbed power

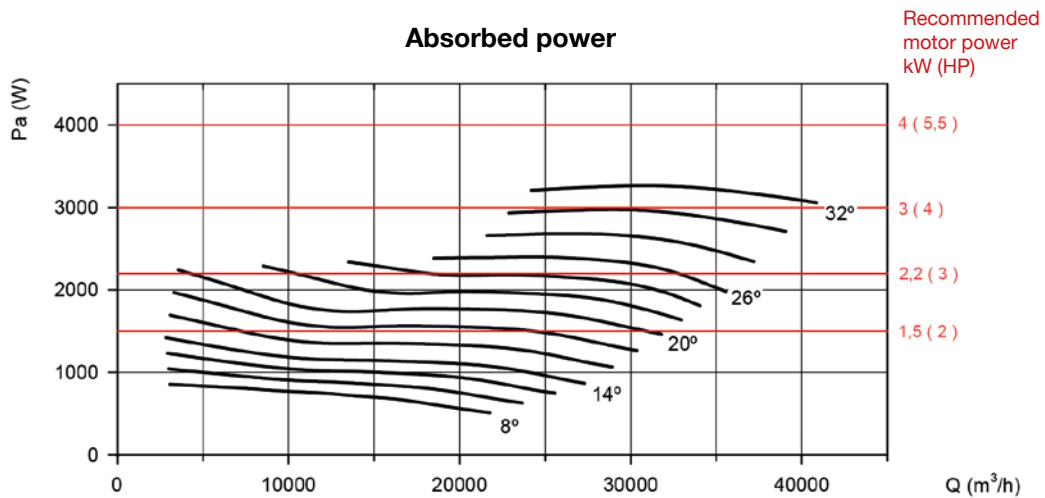

Characteristic curves

Q= Flow rate in m³/h, m³/s and cfm Pe= Static pressure in mm H₂O, Pa and inwg

Impeller diameter in cm: 90

Number of motor poles: 8

Number of blades: 6

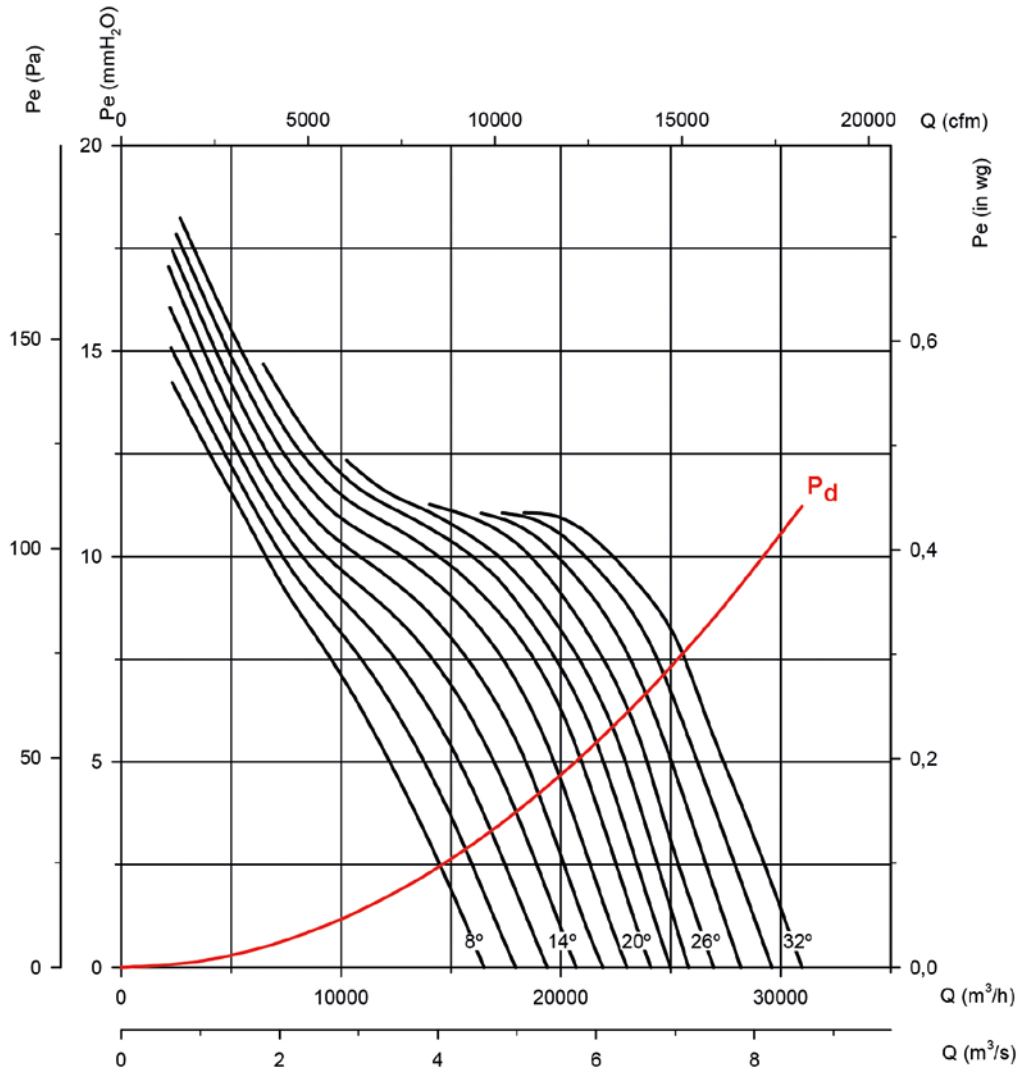

Absorbed power

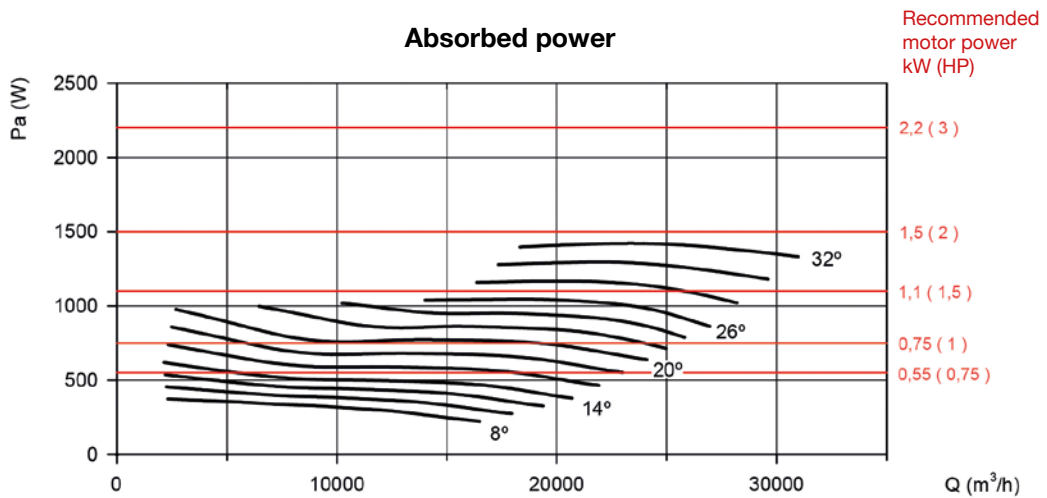

Characteristic curves

Q= Flow rate in m³/h, m³/s and cfm

Pe= Static pressure in mm H₂O, Pa and inwg

Impeller diameter in cm: 100

Number of motor poles: 4

Number of blades: 6

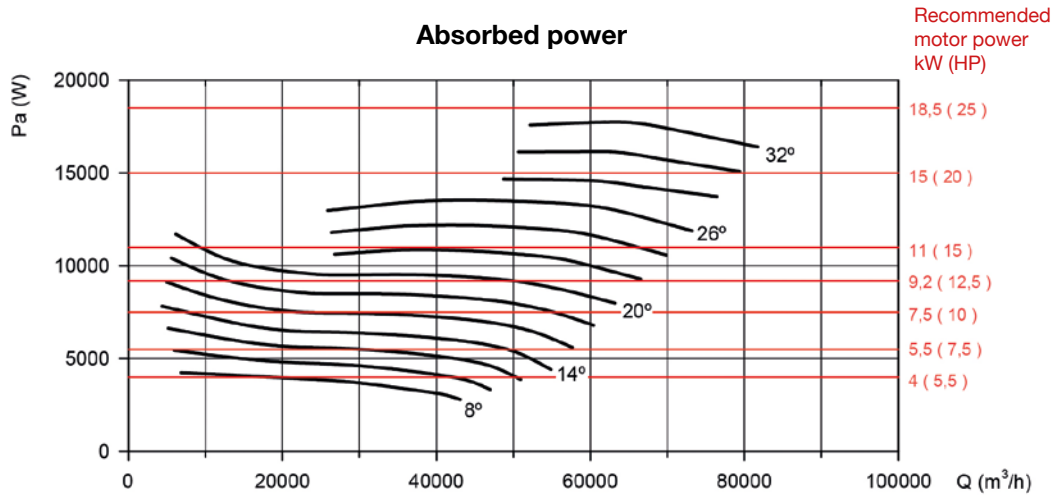
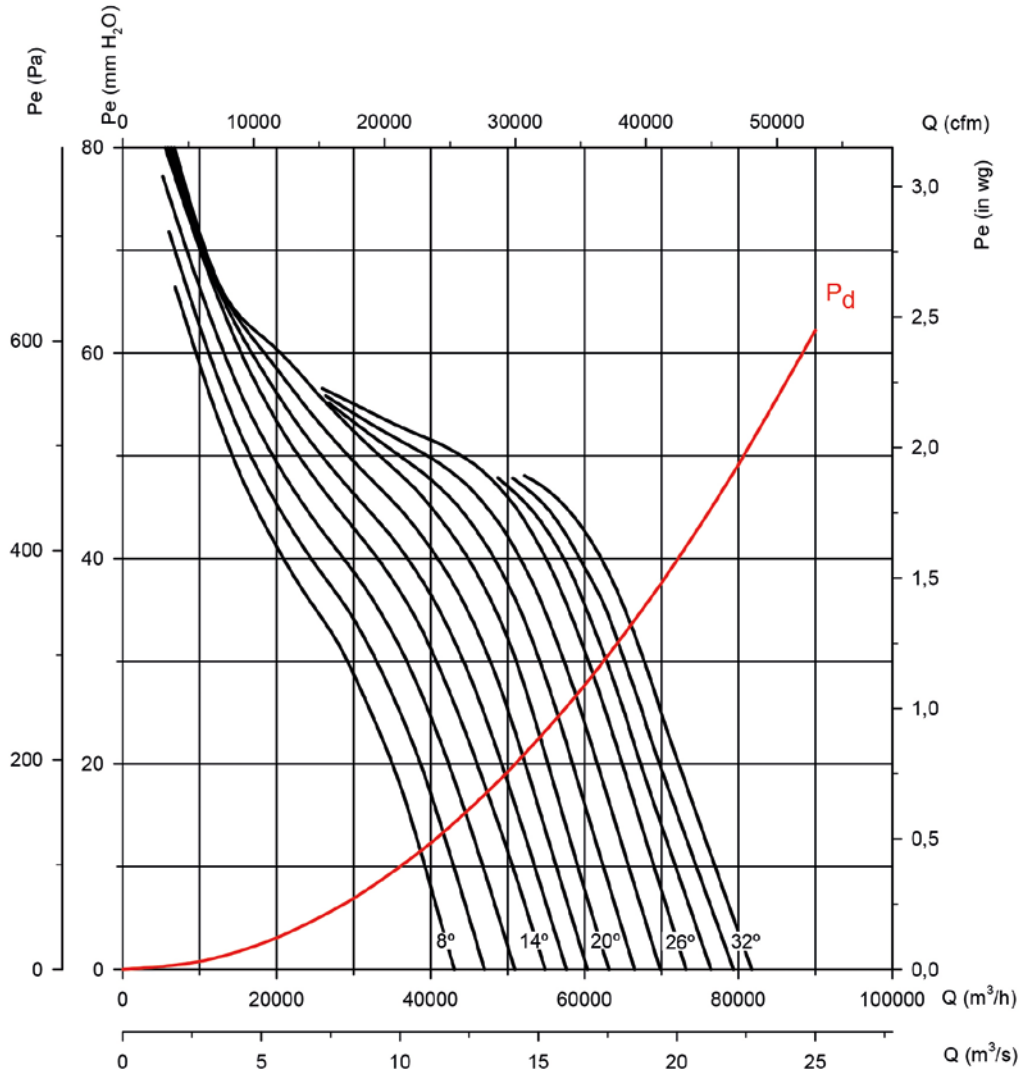

Characteristic curves

Q= Flow rate in m³/h, m³/s and cfm

Pe= Static pressure in mm H₂O, Pa and inwg

Impeller diameter in cm: 100

Number of motor poles: 4

Number of blades: 9

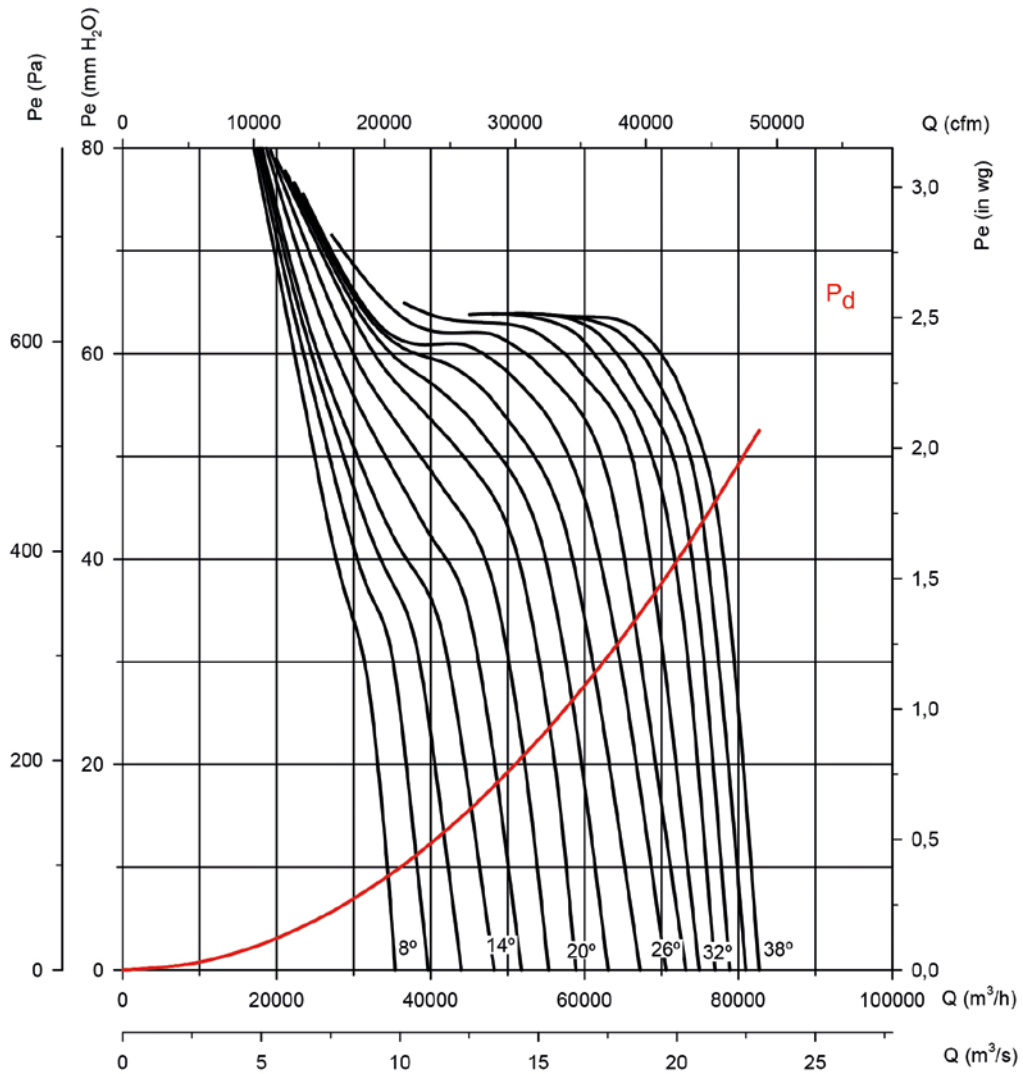

Absorbed power

Recommended motor power kW (HP)

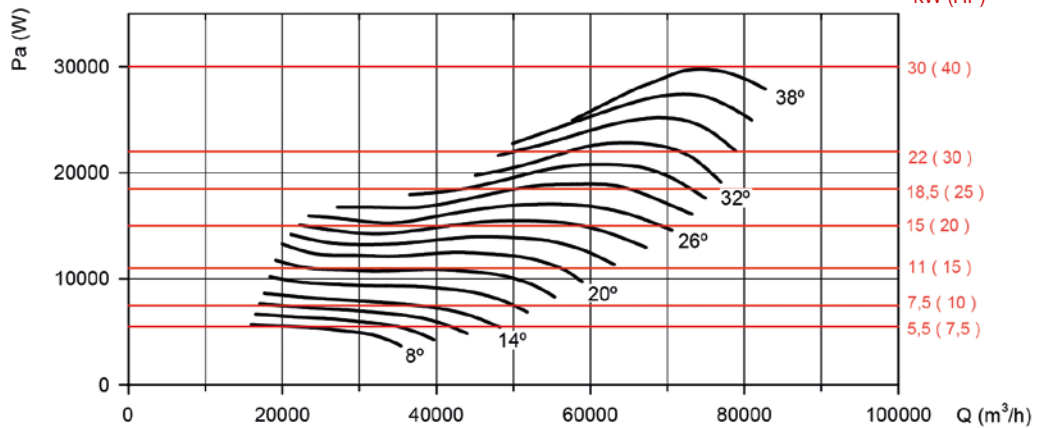

Characteristic curves

Q= Flow rate in m³/h, m³/s and cfm

Pe= Static pressure in mm H₂O, Pa and inwg

Impeller diameter in cm: 100

Number of motor poles: 6

Number of blades: 6

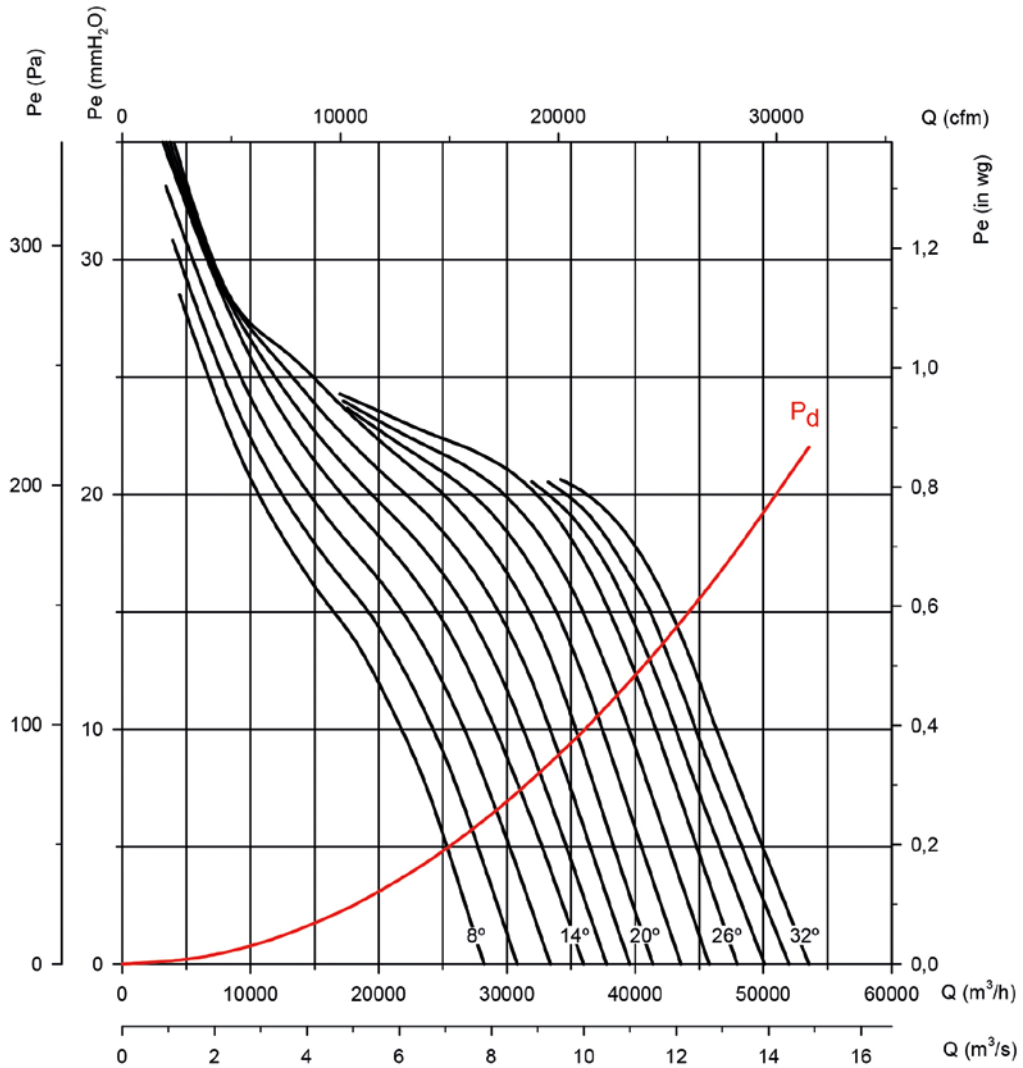

Absorbed power

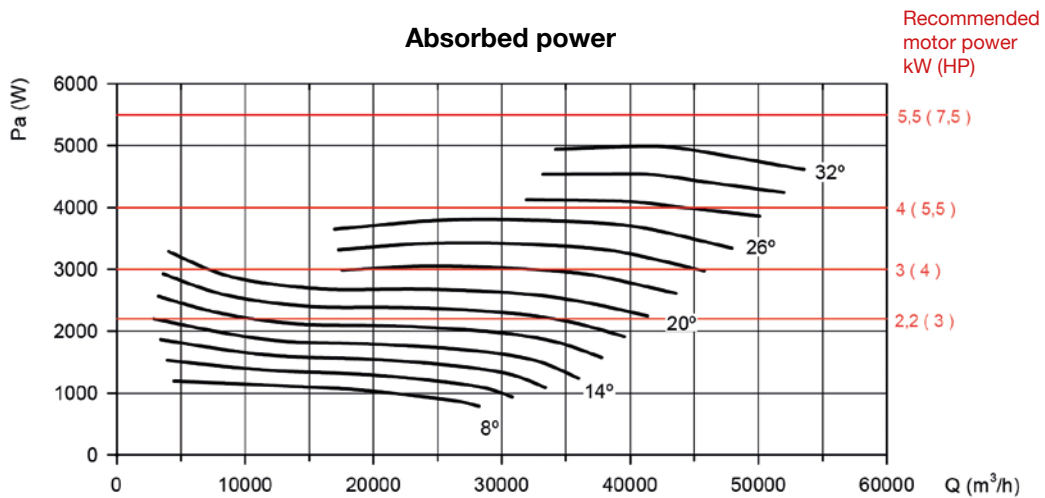

Characteristic curves

Q= Flow rate in m³/h, m³/s and cfm Pe= Static pressure in mm H₂O, Pa and inwg

Impeller diameter in cm: 100

Number of motor poles: 6

Number of blades: 9

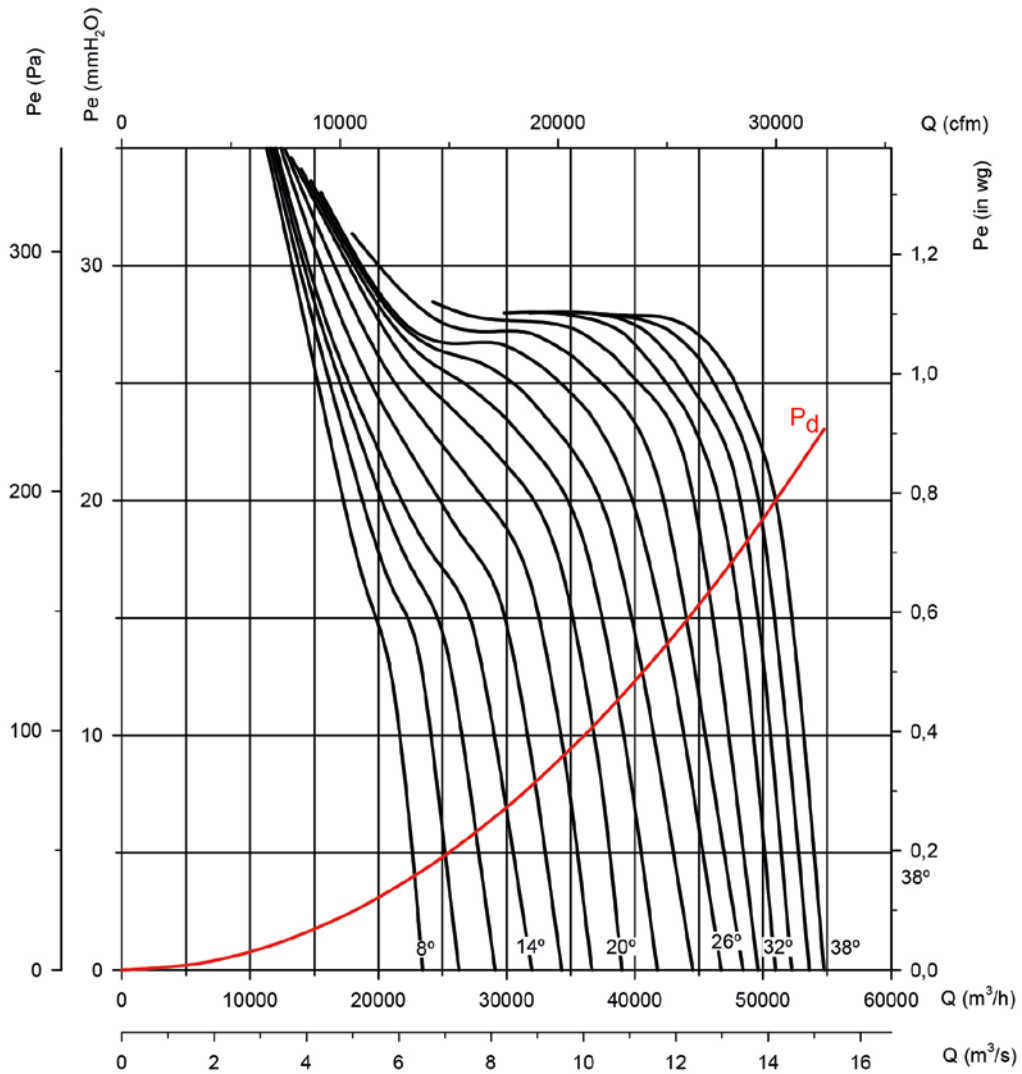

Absorbed power

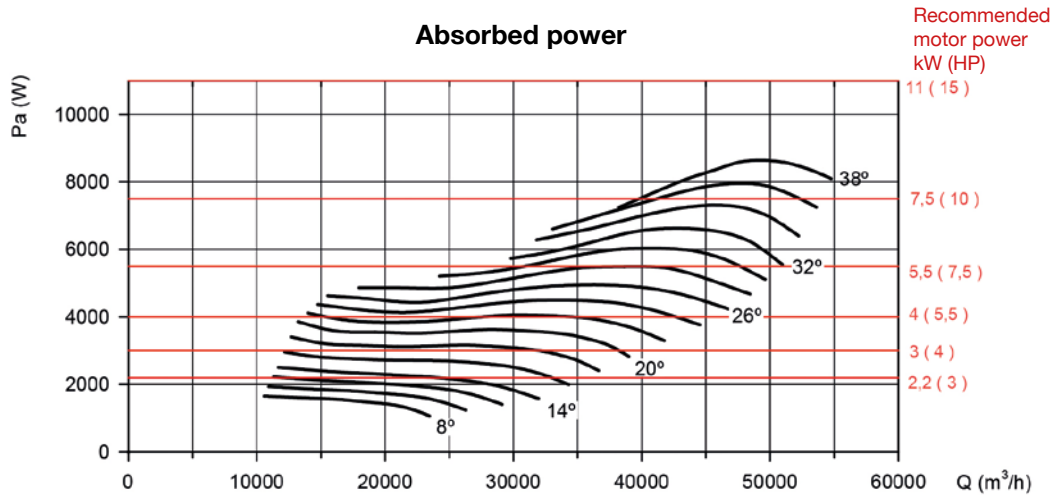

Characteristic curves

Q= Flow rate in m³/h, m³/s and cfm

Pe= Static pressure in mm H₂O, Pa and inwg

Impeller diameter in cm: 125

Number of motor poles: 4

Number of blades: 6

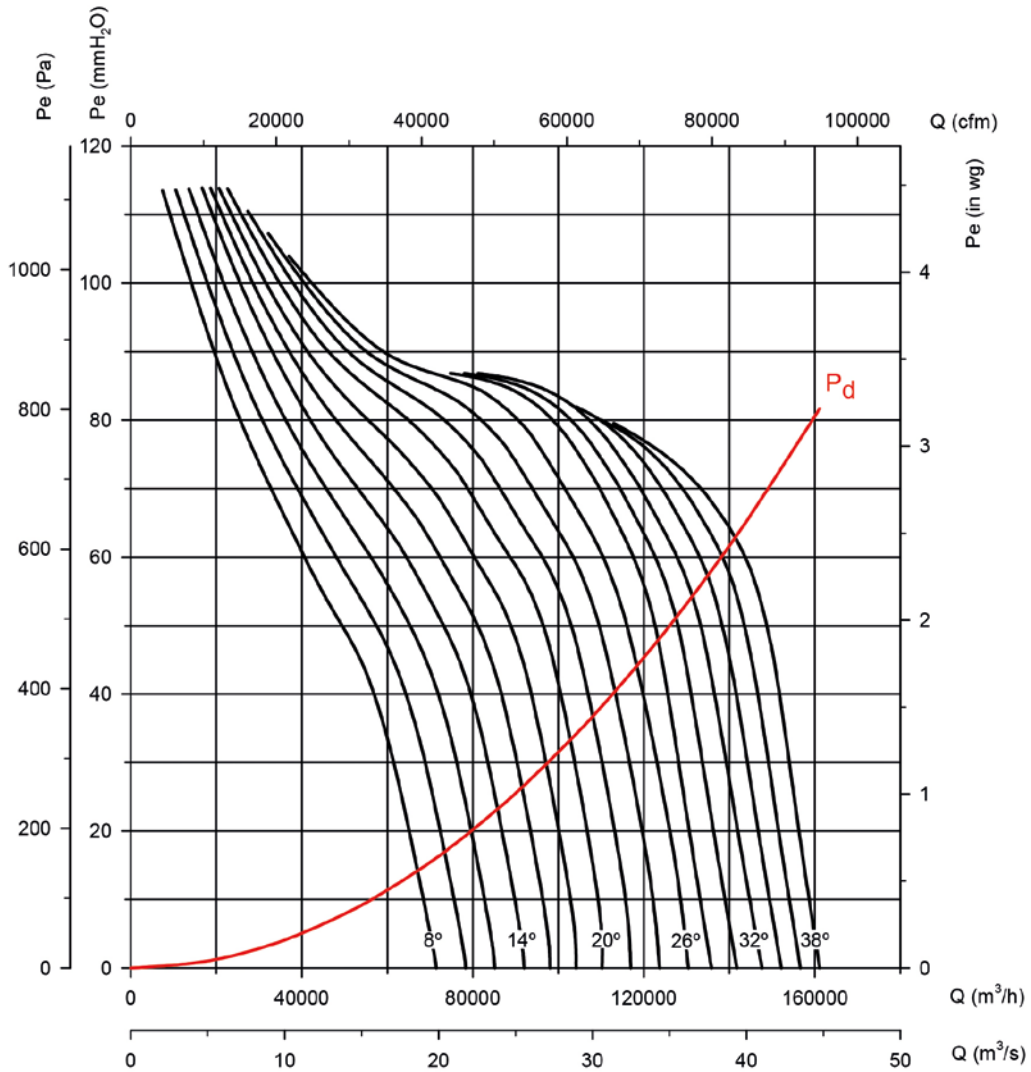

Absorbed power

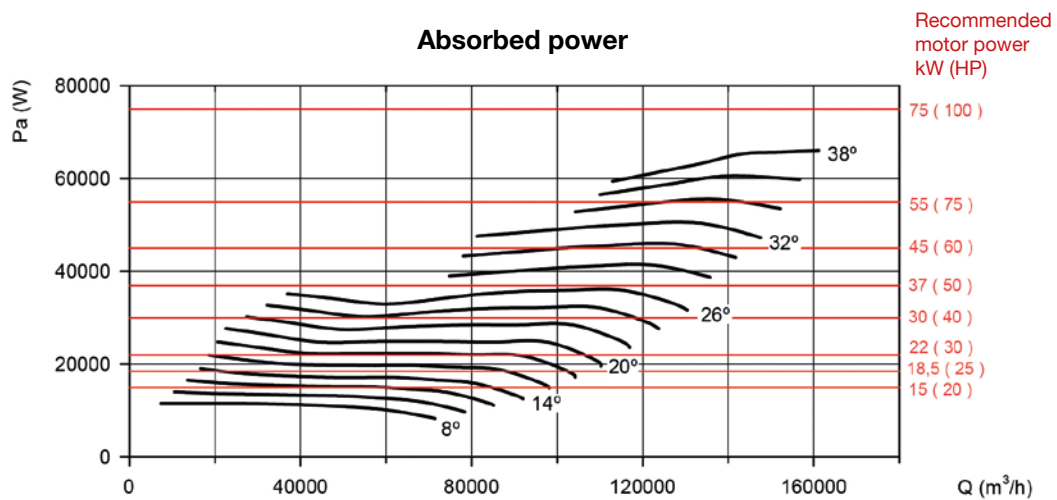

Characteristic curves

Q= Flow rate in m³/h, m³/s and cfm

Pe= Static pressure in mm H₂O, Pa and inwg

Impeller diameter in cm: 125

Number of motor poles: 4

Number of blades: 9

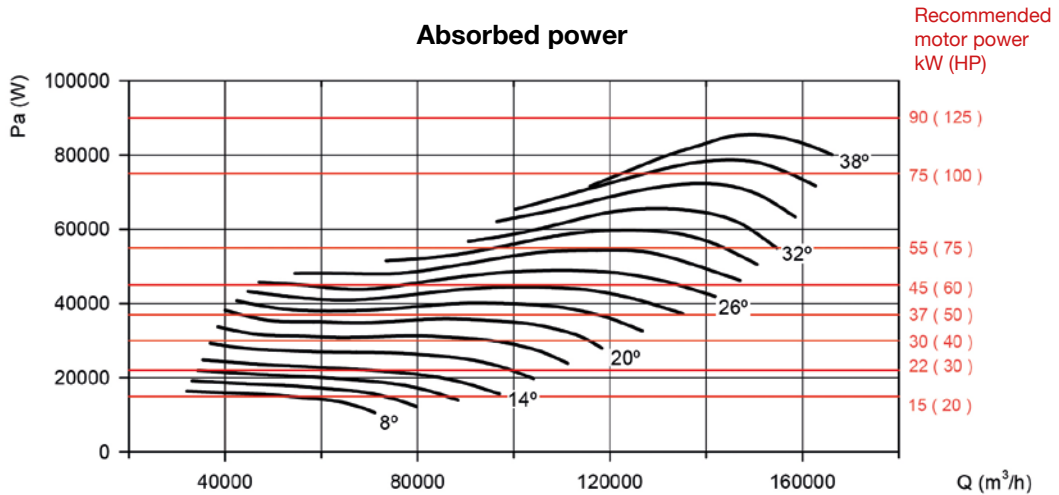
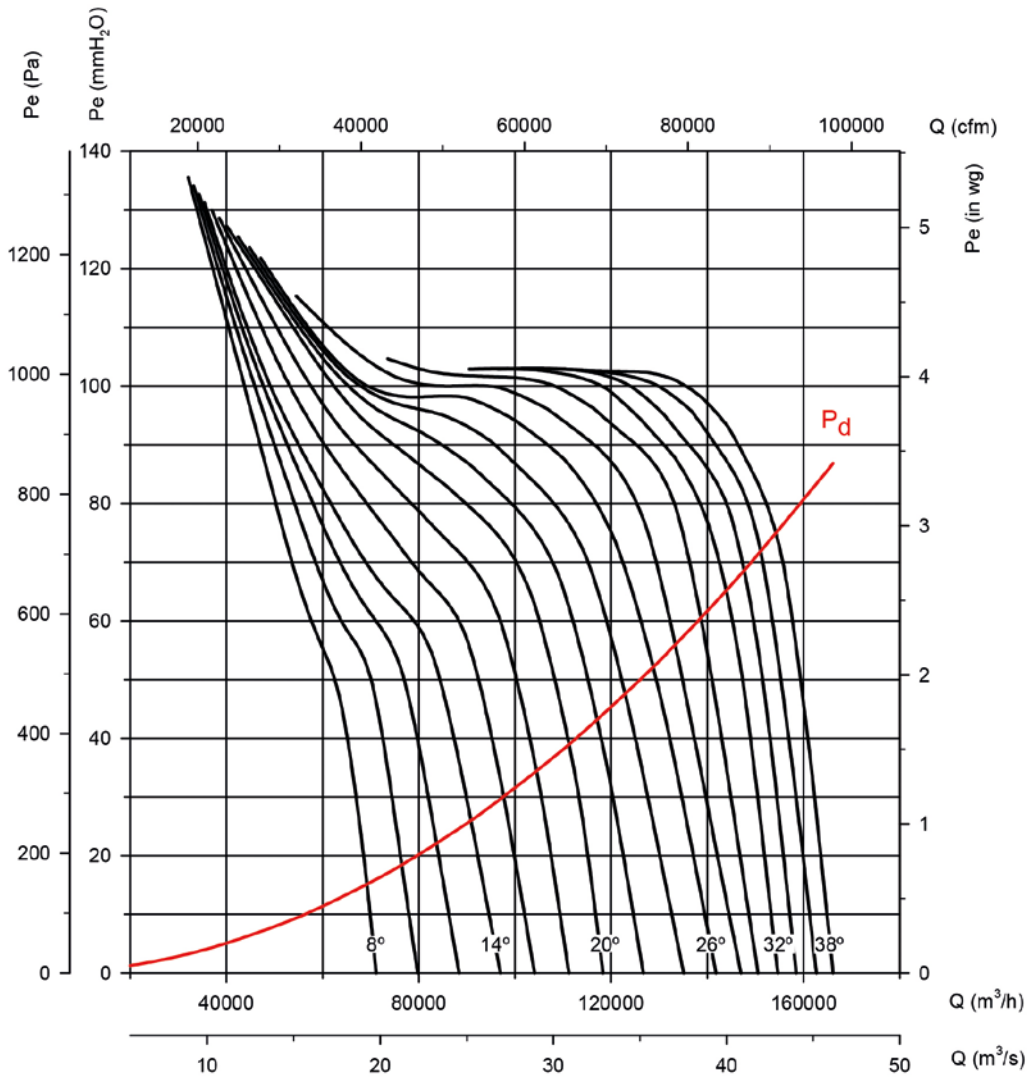

Characteristic curves

Q= Flow rate in m³/h, m³/s and cfm Pe= Static pressure in mm H₂O, Pa and inwg

Impeller diameter in cm: 125

Number of motor poles: 4

Number of blades: 12

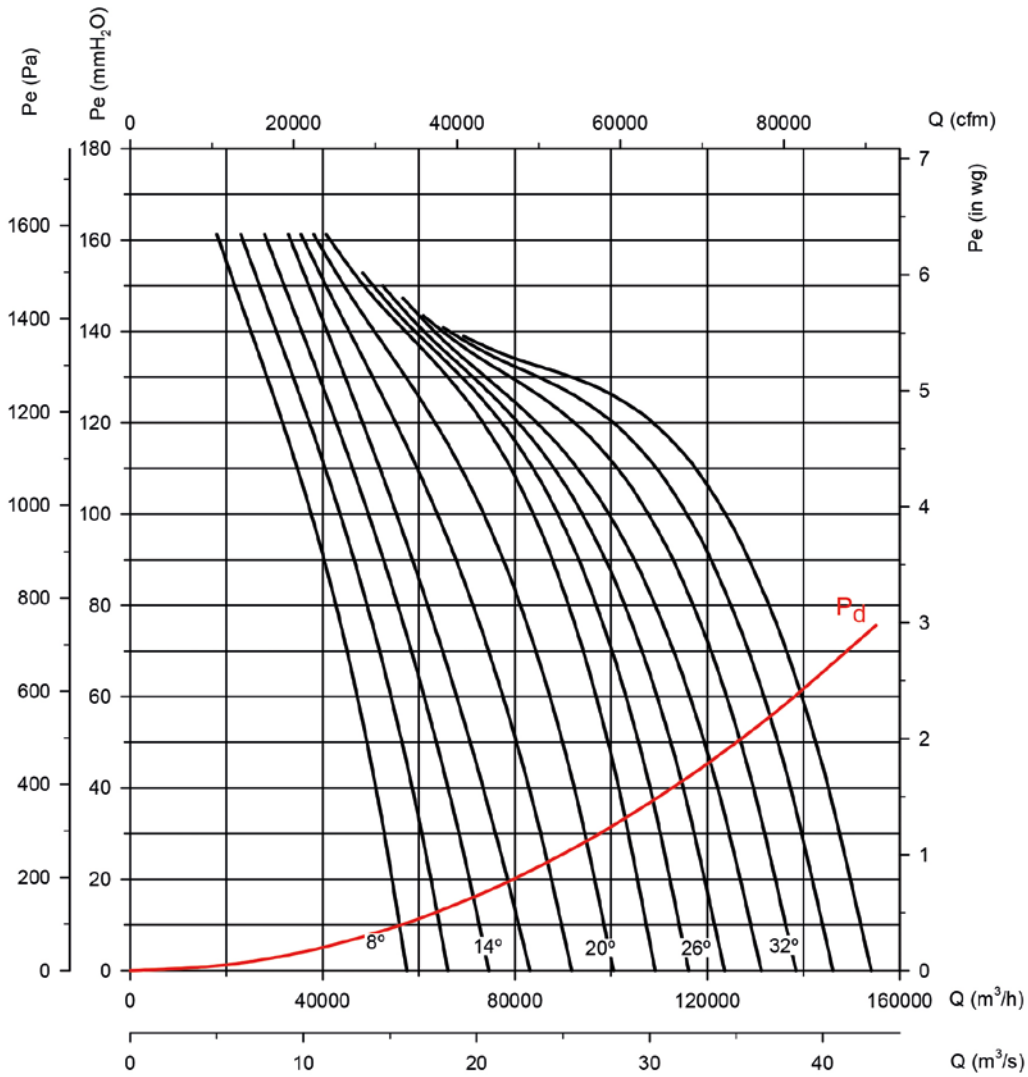

Absorbed power

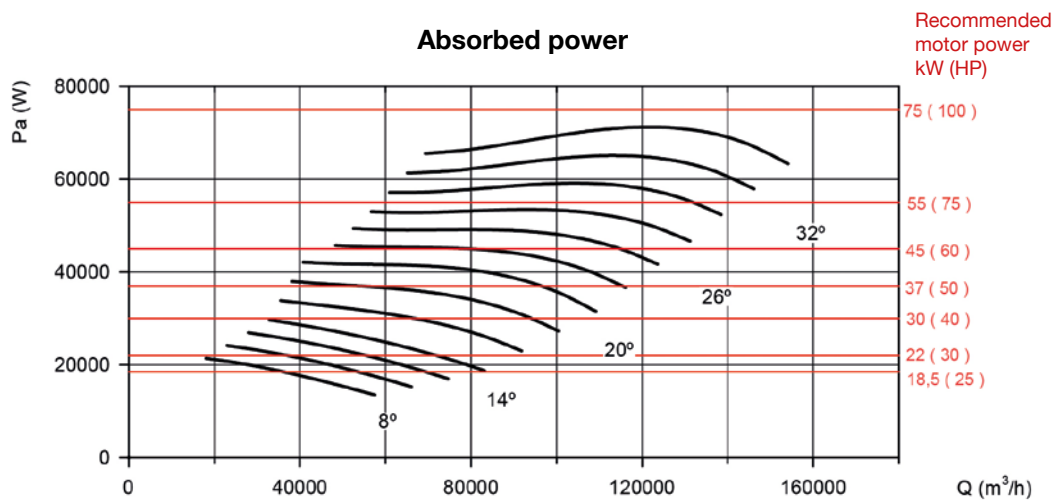

Characteristic curves

Q= Flow rate in m³/h, m³/s and cfm Pe= Static pressure in mm H₂O, Pa and inwg

Impeller diameter in cm: 125

Number of motor poles: 6

Number of blades: 6

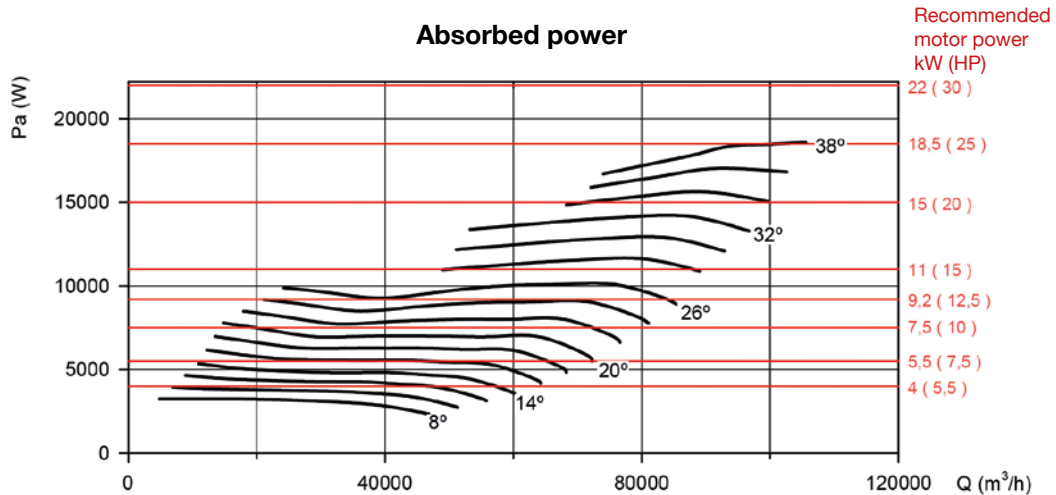
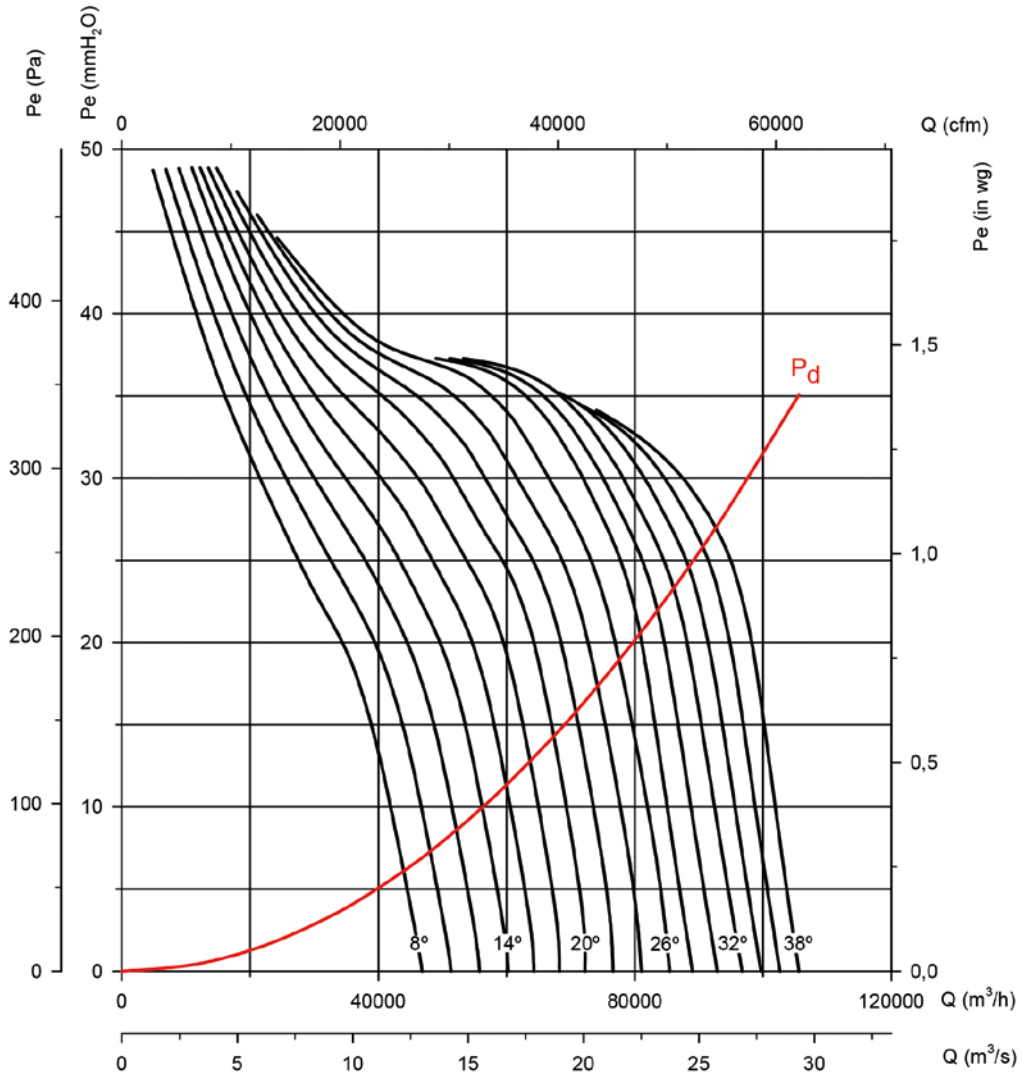

Characteristic curves

Q= Flow rate in m³/h, m³/s and cfm

Pe= Static pressure in mm H₂O, Pa and inwg

Impeller diameter in cm: 125

Number of motor poles: 6

Number of blades: 9

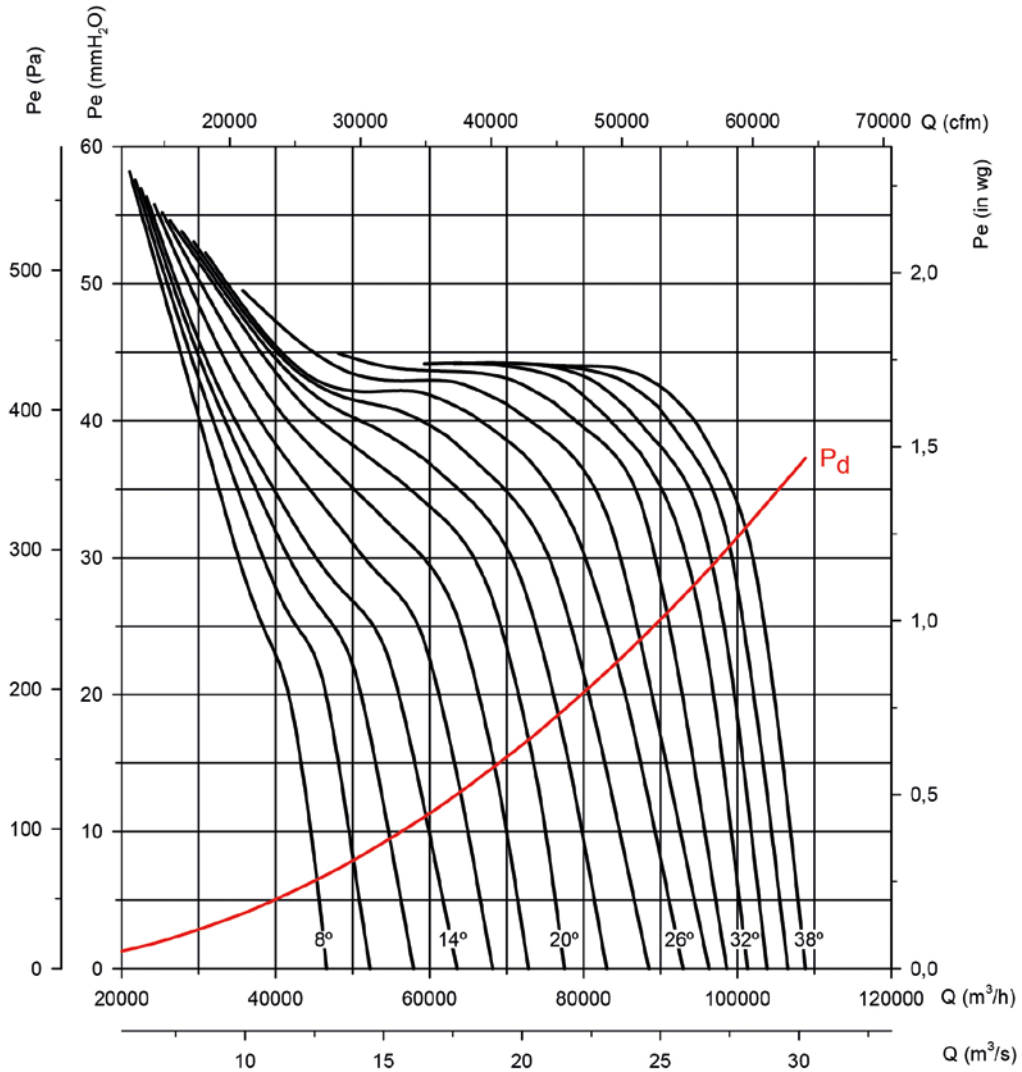

Absorbed power

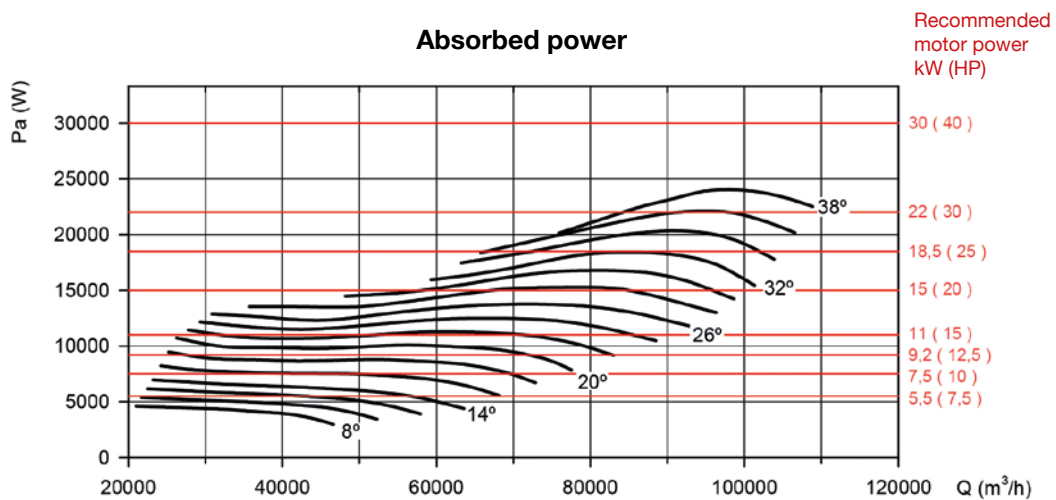

Characteristic curves

Q= Flow rate in m³/h, m³/s and cfm Pe= Static pressure in mm H₂O, Pa and inwg

Impeller diameter in cm: 125

Number of motor poles: 6

Number of blades: 12

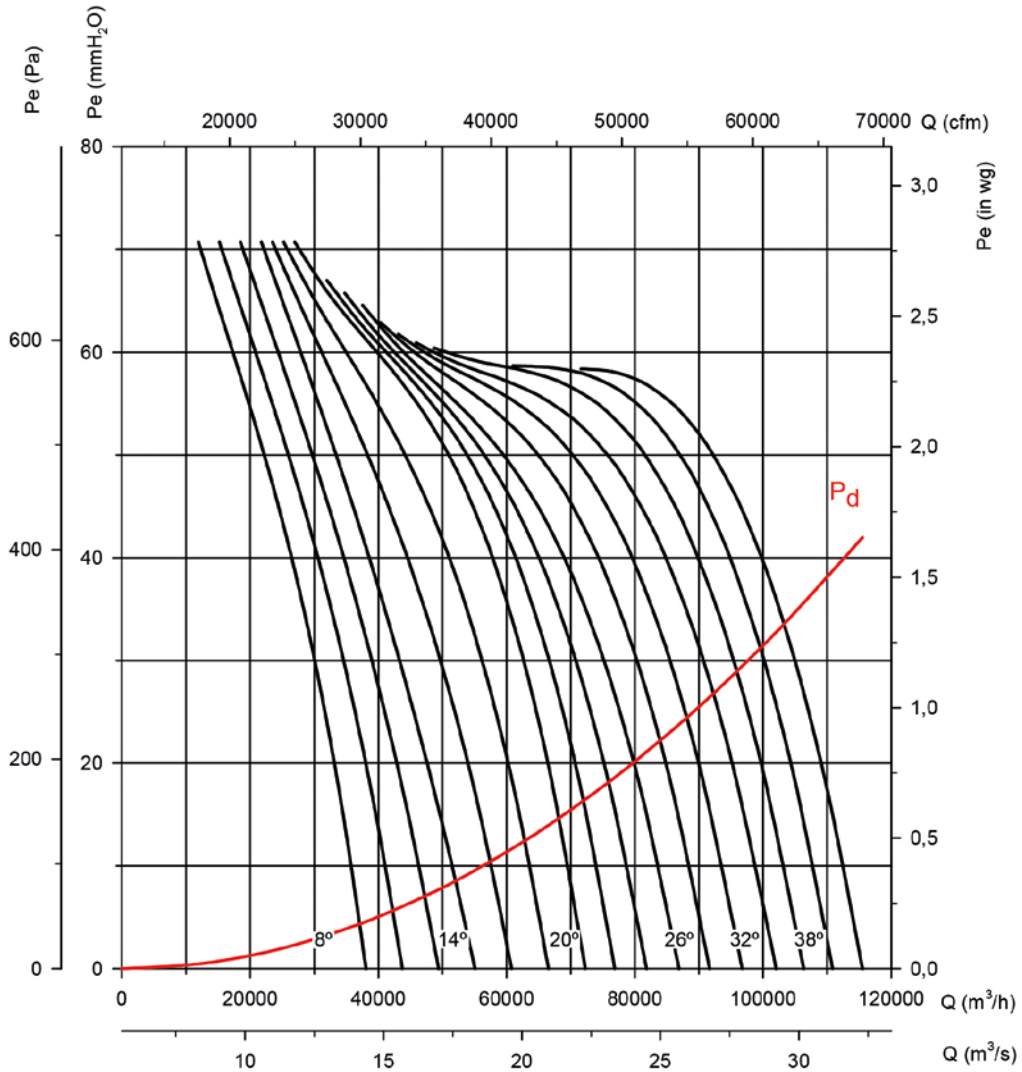

Absorbed power

Recommended motor power kW (HP)

