

# CMR/EW

**MOTORES TRIFÁSICOS DE ALTA Eficiencia IE3**



**VARIADOR VELOCIDAD**  
VSD: Variador electrónico de velocidad.  
· VSD1/A-RFM  
· VSD3/A-RFT  
Suministro según pedido

**CONTROL**  
Suministro como accesorio opcional

**ALIMENTACIÓN**  
VSD1/A-RFM:  
220-240 V 50/60 Hz  
VSD3/A-RFT:  
380-415 V 50/60 Hz

**Ventiladores centrífugos de media presión y simple aspiración con motor directo y turbina con álabes hacia atrás, equipados con motor asíncrono de alta eficiencia IE3 regulable electrónicamente.**

Ventilador:

- Envoltorio en chapa de acero.
- Turbina con álabes a reacción, en chapa de acero de gran robustez.

Motor y variador electrónico:

- Motores eficiencia IE3, regulables electrónicamente.
- Se suministrará el variador de velocidad VSD según pedido.
- Variador electrónico de velocidad (VSD) regulable mediante señal externa de 0-10 V.
- Se recomienda instalar filtros senoidales entre ventilador y variador electrónico de velocidad (VSD), cuando haya gran distancia entre ellos.
- Variador electrónico de velocidad (VSD), disponibles con entrada monofásica 220-240 V 50/60 Hz hasta 3CV (Tipo VSD1/A-RFM) o con entrada trifásica 380-415 V 50/60 Hz (Tipo VSD3/A-RFT). Protección estándar IP20 hasta 15 CV, potencias mayores IP55. Bajo pedido protección IP66 hasta 10 CV.
- Por defecto se entrega el variador electrónico de velocidad (VSD) programado a velocidad constante.
- Temperatura de trabajo ventilador: -25 °C +120 °C.

Temperatura de trabajo (VSD):

- -25 °C +50 °C.
- Motores clase F, con rodamientos a bolas, protección IP55.
- Trifásicos 230/400 V 50 Hz (hasta 4kW) y 400/690 V 50 Hz. (potencias superiores a 4kW)

Acabado:

- Anticorrosivo en resina de poliéster polimerizada a 190 °C, previo desengrase con tratamiento nanotecnológico libre de fosfatos.

Bajo demanda:

- Ventilador preparado para transportar aire hasta 250 °C.
- Ventilador en acero inoxidable.

## Código de pedido del ventilador

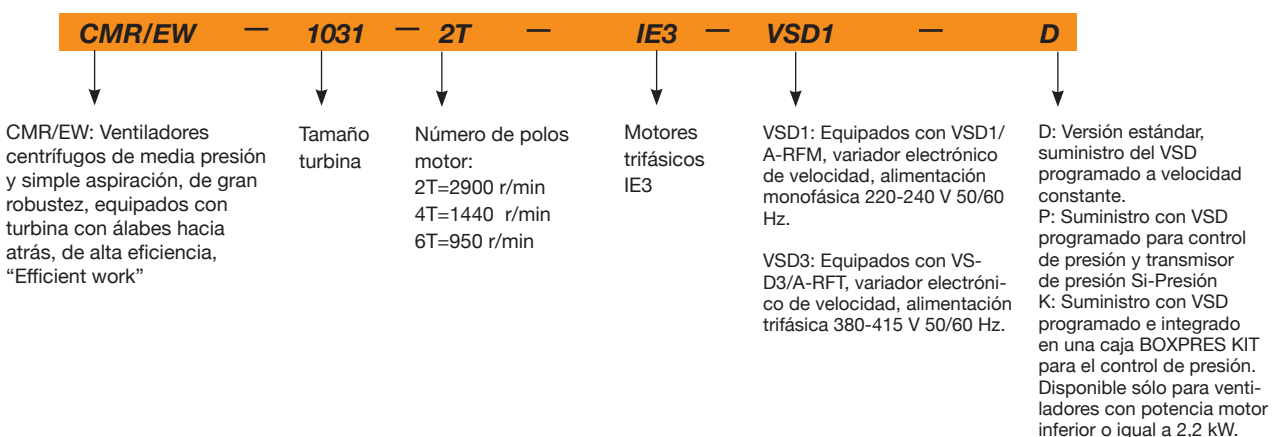
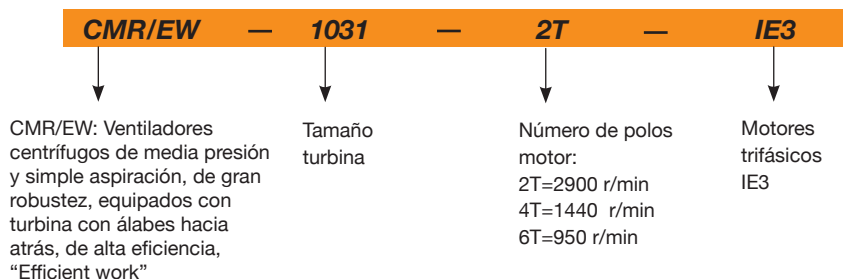



**EFFICIENT WORK**



## Características técnicas

Modelo	Velocidad min/max (r/min)	VSD monofásico 230 V 50/60 Hz		VSD trifásico 400 V 50/60 Hz		Intensidad máxima Motor 50 Hz (A)			Potencia instalada (kW)	Caudal máximo min/max (m³/h)	Nivel presión sonora min/max dB(A)	Peso aprox. (Kg)
		Intensidad máxima entrada (A)	Modelo VSD	Intensidad máxima entrada (A)	Modelo VSD	230V	400V	690V				
CMR/EW-1031-2T	1150/2875	16,15	VSD1/A-RFM-2	4,49	VSD3/A-RFT-2	5,34	3,07	-	1,50	2065 / 5160	60 / 80	44,3
CMR/EW-1135-2T	1165/2910	23,25	VSD1/A-RFM-3	6,46	VSD3/A-RFT-3	7,32	4,21	-	2,20	3125 / 7800	63 / 83	54,9
CMR/EW-1240-2T	1160/2900	-	-	9,44	VSD3/A-RFT-5.5	13,00	7,50	-	4,00	4440 / 11100	66 / 86	93,5
CMR/EW-1240-4T	570/1420	8,32	VSD1/A-RFM-1	2,31	VSD3/A-RFT-1	2,82	1,62	-	0,75	2330 / 5800	51 / 71	70,5
CMR/EW-1445-2T	1175/2935	-	-	17,45	VSD3/A-RFT-10	-	13,90	8,06	7,50	6605 / 16500	67 / 87	126,0
CMR/EW-1445-4T	580/1455	11,87	VSD1/A-RFM-2	3,30	VSD3/A-RFT-2	4,07	2,34	-	1,10	3200 / 8030	52 / 72	92,5
CMR/EW-1650-2T	1170/2925	-	-	25,48	VSD3/A-RFT-15	-	19,60	11,40	11,00	7540 / 18850	69 / 89	178,0
CMR/EW-1650-4T	575/1440	15,78	VSD1/A-RFM-2	4,38	VSD3/A-RFT-2	5,41	3,11	-	1,50	4195 / 10500	54 / 74	114,0
CMR/EW-1650-6T	375/940	8,69	VSD1/A-RFM-1	2,41	VSD3/A-RFT-1	3,36	1,93	-	0,75	2955 / 7410	44 / 64	114,0
CMR/EW-1856-4T	575/1440	-	-	7,20	VSD3/A-RFT-5.5	10,70	6,15	-	3,00	6050 / 15150	59 / 79	152,0
CMR/EW-1856-6T	380/945	12,43	VSD1/A-RFM-2	3,45	VSD3/A-RFT-2	4,68	2,69	-	1,10	4040 / 10050	50 / 70	146,5
CMR/EW-2063-4T	585/1465	-	-	12,81	VSD3/A-RFT-7.5	-	10,30	5,97	5,50	9765 / 24450	60 / 80	226,0
CMR/EW-2063-6T	380/950	16,64	VSD1/A-RFM-2	4,62	VSD3/A-RFT-2	6,43	3,70	-	1,50	6440 / 16100	51 / 71	208,5
CMR/EW-2271-4T	590/1470	-	-	25,10	VSD3/A-RFT-15	-	21,40	12,40	11,00	13890 / 34610	65 / 85	315,0
CMR/EW-2271-6T	390/970	-	-	7,39	VSD3/A-RFT-5.5	12,00	6,91	-	3,00	9145 / 22750	56 / 76	293,5
CMR/EW-2380-4T	590/1475	-	-	49,98	VSD3/A-RFT-30	-	40,60	23,50	22,00	19200 / 48000	63 / 83	416,0
CMR/EW-2380-6T	390/970	-	-	17,59	VSD3/A-RFT-10	-	14,80	8,58	7,50	12060 / 30000	55 / 75	363,0

## Características acústicas a velocidad máxima

Los valores indicados se determinan mediante medidas de potencia sonora en dB(A) obtenidas en campo libre a una distancia equivalente a dos veces la envergadura del ventilador más el diámetro de la turbina, con un mínimo de 1,5m.

Espectro de potencia sonora Lw(A) en dB(A) banda de frecuencia en [Hz]

Modelo	63	125	250	500	1000	2000	4000	8000	Modelo	63	125	250	500	1000	2000	4000	8000
CMR/EW-1031-2T	65	78	78	91	86	86	86	79	CMR/EW-1856-4T	69	78	91	87	90	91	85	71
CMR/EW-1135-2T	72	79	77	89	87	93	92	79	CMR/EW-1856-6T	61	69	81	83	80	81	71	60
CMR/EW-1240-2T	68	83	81	93	90	94	96	83	CMR/EW-2063-4T	80	85	91	93	91	88	81	73
CMR/EW-1240-4T	56	70	76	79	79	80	70	59	CMR/EW-2063-6T	69	70	82	82	81	83	73	63
CMR/EW-1445-2T	73	85	83	95	93	97	99	89	CMR/EW-2271-4T	83	84	93	96	98	99	95	82
CMR/EW-1445-4T	59	72	78	83	80	83	78	64	CMR/EW-2271-6T	73	73	87	86	90	90	79	68
CMR/EW-1650-2T	73	81	85	99	97	99	99	88	CMR/EW-2380-4T	76	78	94	91	96	97	93	82
CMR/EW-1650-4T	64	74	82	84	83	85	76	66	CMR/EW-2380-6T	68	70	86	83	88	89	85	74
CMR/EW-1650-6T	53	65	72	77	73	69	62	54									

## Dimensiones mm

CMR/EW-1031...2271

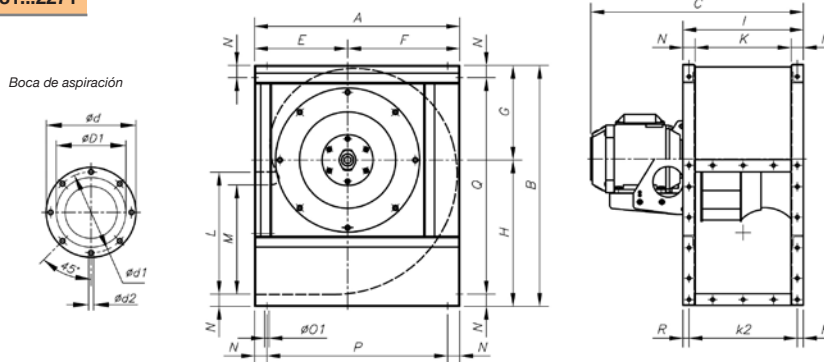

Modelo	A	B	C	øD1*	ød	ød1	ød2	E	F	G	H	I	K	k2	L	M	N	øO1	P	Q	R
CMR/EW-1031-2T	542	626	573,5	315	383	356	M8	250	292	245	381	320	250	285	315	276	35	11	472	556	17,5
CMR/EW-1135-2T	600	696	656	355	425	398	M8	275	325	273	423	350	280	315	355	310	35	11	530	626	17,5
CMR/EW-1240-2T	673	790	728	400	472	444	M10	305	368	310	480	395	315	355	400	358	40	11	593	710	20
CMR/EW-1240-4T	673	790	590	400	472	444	M10	305	368	310	480	395	315	355	400	358	40	11	593	710	20
CMR/EW-1445-2T	765	880	810	450	522	494	M10	350	415	339	541	445	355	403	450	404	45	11	675	790	21
CMR/EW-1445-4T	765	880	649	450	522	494	M10	350	415	339	541	445	355	403	450	404	45	11	675	790	21
CMR/EW-1650-2T	832	970	961	500	582	555	M10	375	457	378	592	490	400	450	500	445	45	13	742	880	20
CMR/EW-1650-4T	832	970	715	500	582	555	M10	375	457	378	592	490	400	450	500	445	45	13	742	880	20
CMR/EW-1650-6T	832	970	695	500	582	555	M10	375	457	378	592	490	400	450	500	445	45	13	742	880	20
CMR/EW-1856-4T	925	1084	832	560	645	615	M10	415	510	426	658	550	450	500	560	493	50	13	825	984	25
CMR/EW-1856-6T	925	1084	771	560	645	615	M10	415	510	426	658	550	450	500	560	493	50	13	825	984	25
CMR/EW-2063-4T	1037	1218	973	630	720	688	M10	465	572	477	741	620	500	560	630	530	60	13	917	1098	30
CMR/EW-2063-6T	1037	1218	893	630	720	688	M10	465	572	477	741	620	500	560	630	530	60	13	917	1098	30
CMR/EW-2271-4T	1173	1375	1126	710	800	768	M12	525	648	538	837	690	560	625	710	603	65	13	1043	1245	32,5
CMR/EW-2271-6T	1173	1375	1039	710	800	768	M12	525	648	538	837	690	560	625	710	603	65	13	1043	1245	32,5

## Dimensiones mm

### CMR/EW-2380

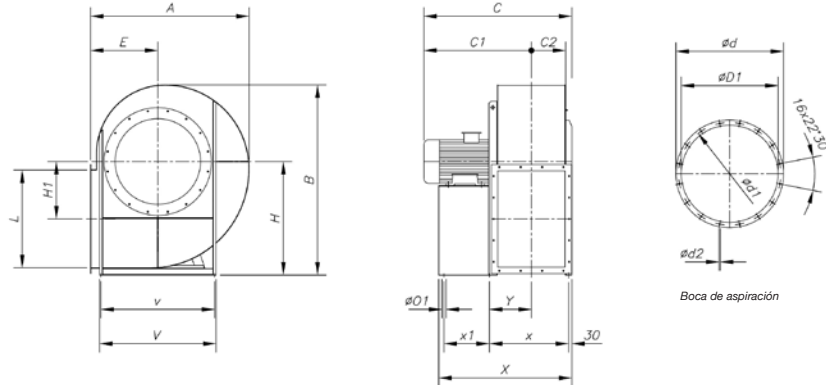

Modelo	A	B	C	C1	C2	D1	d	d1	d2	E	H	H1	L	O1	V	v	X	x	x1	Y
CMR-2380-4T	1350	1660	1245	895	345	808	903	861	11,5	560	1000	500	820	17	930	870	1103	668	370	352,5
CMR-2380-6T	1350	1660	1175	825	345	808	903	861	11,5	560	1000	500	820	17	930	870	1051	651	340	342,5

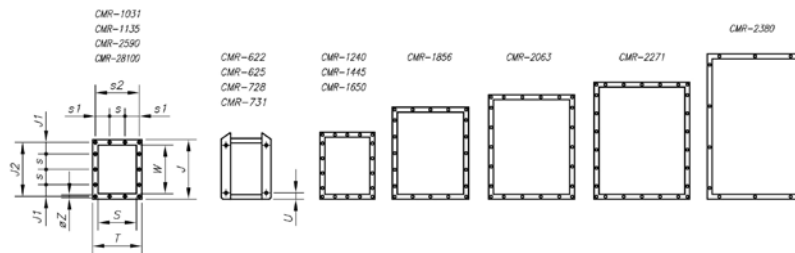

### Boca impulsión

Modelo	T	J	J1	J2	S	s	s1	s2	W	$\phi z$	U
CMR-1031	320	385	75	350	250	100	92,5	285	315	9	-
CMR-1135	350	425	95	390	280	100	107,5	315	355	9	-
CMR-1240	395	480	70	440	315	100	77,5	355	400	11	-
CMR-1445	445	540	99	498	355	100	102,5	403	450	11	-
CMR-1650	490	590	88	550	400	125	100	450	500	11	-
CMR-1856	550	660	55	610	450	125	125	500	560	13	-
CMR-2063	620	750	95	690	500	125	92,5	560	630	13	-
CMR-2271	690	840	75	775	560	125	62,5	625	710	13	-
CMR-2380	680	920	160	871	560	200	140	639	800	14	-

## Orientaciones

Suministro standard LG 270

Modelos 2380, 2590 y 28100 orientación fija LG 270 (otras orientaciones sólo bajo demanda)



LG 0



LG 90



LG 180



LG 270



RD 0



RD 90



RD 180



RD 270



EFFICIENT WORK



Erp. Curvas características y datos ErP

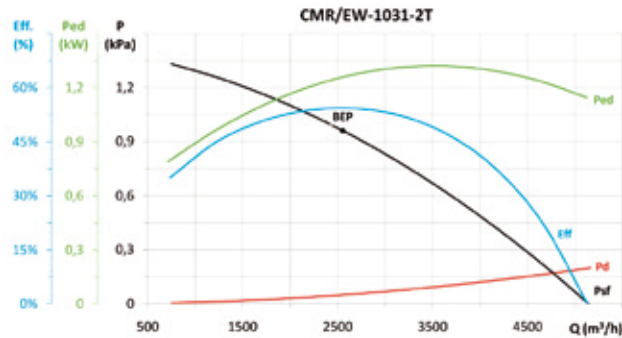

MC	EC	SR	Cc	$\eta_e$ (%)*	N	[kW]	[m <sup>3</sup> /h]	[Pa]	[rpm]	VSD
A	S	1,01	1,08	58,8%	68,2	1,254	2553	961,3	2916	NECESSARY

\* $\eta_e$  (%) = Eff. (%) x Cc

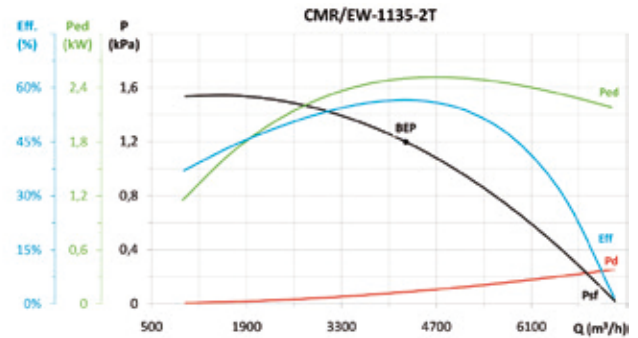

MC	EC	SR	Cc	$\eta_e$ (%)*	N	[kW]	[m <sup>3</sup> /h]	[Pa]	[rpm]	VSD
A	S	1,01	1,06	60,0%	66,3	2,500	4249	1198,6	2916	NECESSARY

\* $\eta_e$  (%) = Eff. (%) x Cc

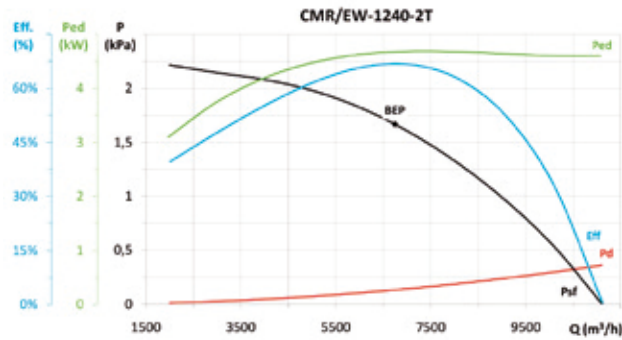

MC	EC	SR	Cc	$\eta_e$ (%)*	N	[kW]	[m <sup>3</sup> /h]	[Pa]	[rpm]	VSD
A	S	1,02	1,04	69,6%	73,1	4,675	6744	1667,2	2901	NECESSARY

\* $\eta_e$  (%) = Eff. (%) x Cc

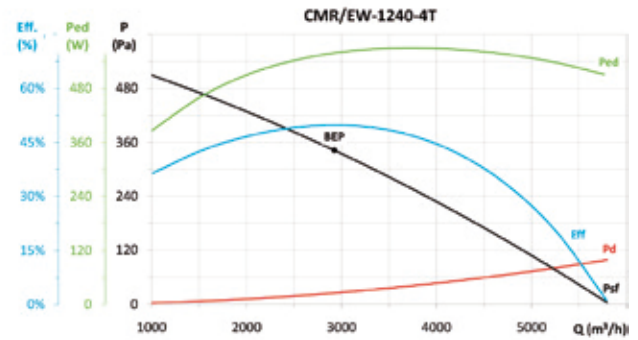

MC	EC	SR	Cc	$\eta_e$ (%)*	N	[kW]	[m <sup>3</sup> /h]	[Pa]	[rpm]	VSD
A	S	1,00	1,11	55,1%	68,2	0,558	2924	342,3	1453	NECESSARY

\* $\eta_e$  (%) = Eff. (%) x Cc

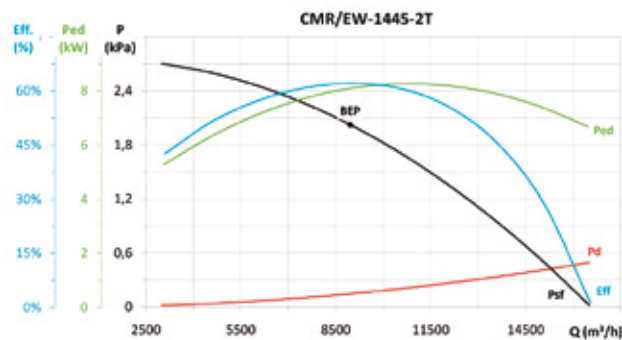

MC	EC	SR	Cc	$\eta_e$ (%)*	N	[kW]	[m <sup>3</sup> /h]	[Pa]	[rpm]	VSD
A	S	1,02	1,04	64,6%	65,6	8,103	8951	2025,7	2939	NECESSARY

\* $\eta_e$  (%) = Eff. (%) x Cc

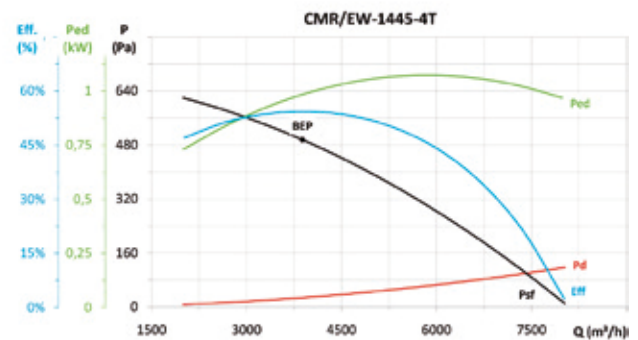

MC	EC	SR	Cc	$\eta_e$ (%)*	N	[kW]	[m <sup>3</sup> /h]	[Pa]	[rpm]	VSD
A	S	1,01	1,09	59,1%	69,7	0,983	3883	495,3	1468	NECESSARY

\* $\eta_e$  (%) = Eff. (%) x Cc

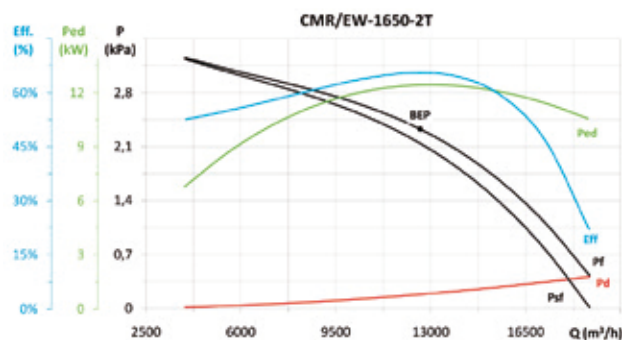

MC	EC	SR	Cc	$\eta_e$ (%)*	N	[kW]	[m <sup>3</sup> /h]	[Pa]	[rpm]	VSD
B	T	1,02	1,04	68,2%	68,0	12,431	12602	2328,0	2927	NECESSARY

\* $\eta_e$  (%) = Eff. (%) x Cc

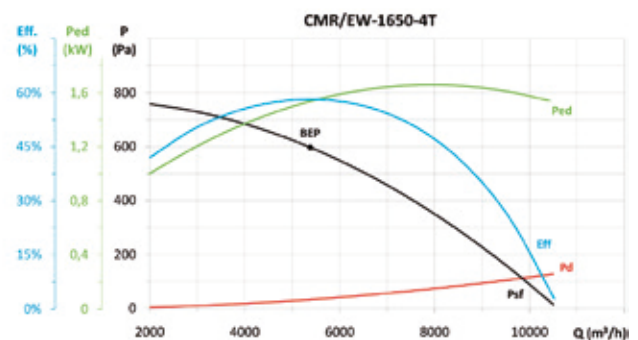

MC	EC	SR	Cc	$\eta_e$ (%)*	N	[kW]	[m <sup>3</sup> /h]	[Pa]	[rpm]	VSD
A	S	1,01	1,08	62,5%	71,1	1,535	5378	597,4	1449	NECESSARY

\* $\eta_e$  (%) = Eff. (%) x Cc



## Erp. Curvas características y datos ErP

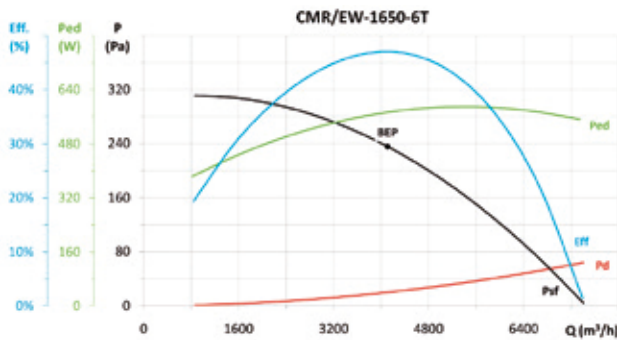

MC	EC	SR	Cc	$\eta_e$ (%)*	N	[kW]	[m <sup>3</sup> /h]	[Pa]	[rpm]	VSD
A	S	1,00	1,10	52,0%	65,0	0,572	4109	235,7	966	NECESSARY

\* $\eta_e$  (%) = Eff. (%) x Cc

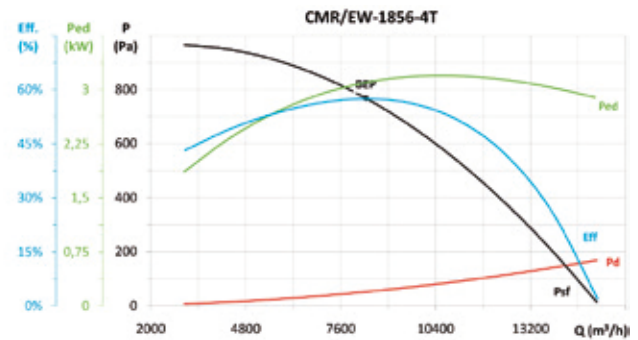

MC	EC	SR	Cc	$\eta_e$ (%)*	N	[kW]	[m <sup>3</sup> /h]	[Pa]	[rpm]	VSD
A	S	1,01	1,05	60,6%	65,9	3,096	8342	768,0	1448	NECESSARY

\* $\eta_e$  (%) = Eff. (%) x Cc

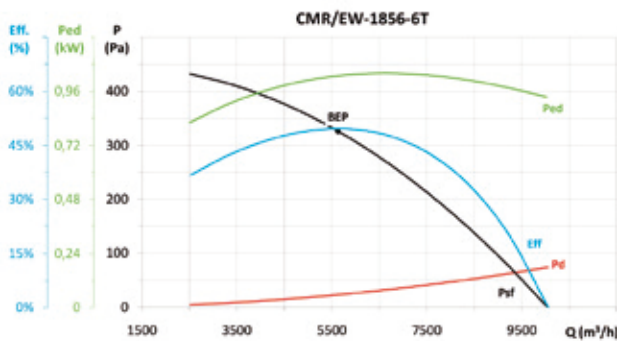

MC	EC	SR	Cc	$\eta_e$ (%)*	N	[kW]	[m <sup>3</sup> /h]	[Pa]	[rpm]	VSD
A	S	1,00	1,09	53,9%	64,3	1,028	5632	326,1	960	NECESSARY

\* $\eta_e$  (%) = Eff. (%) x Cc

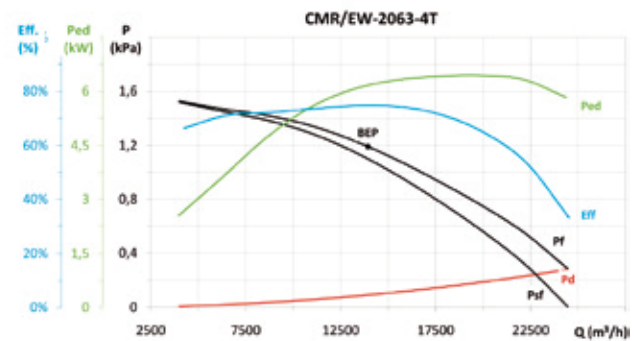

MC	EC	SR	Cc	$\eta_e$ (%)*	N	[kW]	[m <sup>3</sup> /h]	[Pa]	[rpm]	VSD
B	T	1,01	1,04	77,8%	80,0	6,161	13932	1190,7	1466	NECESSARY

\* $\eta_e$  (%) = Eff. (%) x Cc

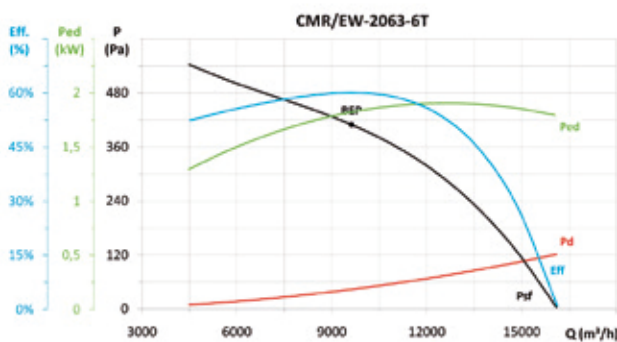

MC	EC	SR	Cc	$\eta_e$ (%)*	N	[kW]	[m <sup>3</sup> /h]	[Pa]	[rpm]	VSD
A	S	1,00	1,07	64,3%	72,1	1,822	9620	409,7	952	NECESSARY

\* $\eta_e$  (%) = Eff. (%) x Cc

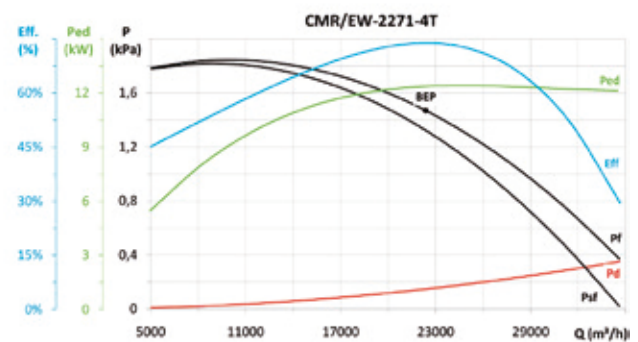

MC	EC	SR	Cc	$\eta_e$ (%)*	N	[kW]	[m <sup>3</sup> /h]	[Pa]	[rpm]	VSD
B	T	1,01	1,04	76,8%	76,7	12,369	22380	1469,6	1470	NECESSARY

\* $\eta_e$  (%) = Eff. (%) x Cc

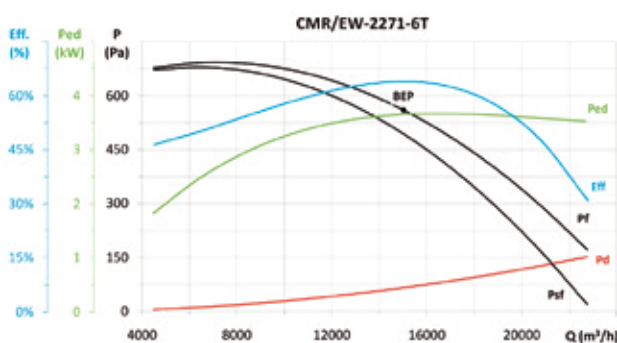

MC	EC	SR	Cc	$\eta_e$ (%)*	N	[kW]	[m <sup>3</sup> /h]	[Pa]	[rpm]	VSD
B	T	1,01	1,05	67,1%	71,7	3,654	15016	560,2	970	NECESSARY

\* $\eta_e$  (%) = Eff. (%) x Cc

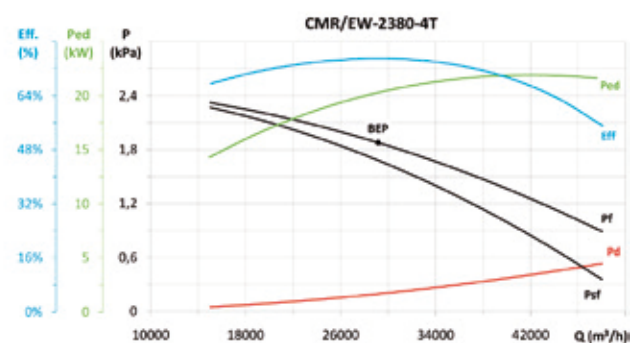

MC	EC	SR	Cc	$\eta_e$ (%)*	N	[kW]	[m <sup>3</sup> /h]	[Pa]	[rpm]	VSD
B	T	1,02	1,04	78,0%	77,3	20,266	29151	1877,3	1480	NECESSARY

\* $\eta_e$  (%) = Eff. (%) x Cc



**EFFICIENT WORK**



## Erp. Curvas características y datos ErP

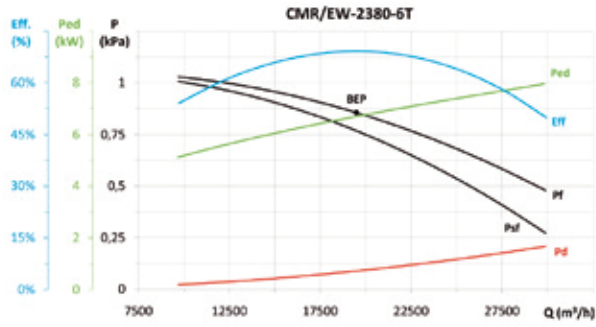

MC	EC	SR	Cc	$\eta_r$ (%)*	N	[kW]	[m³/h]	[Pa]	[rpm]	VSD
B	T	1,01	1,04	72,0%	73,8	6,696	19494	855,7	977	NECESSARY

\* $\eta_{pe}$  (%) = Eff. (%) x Cc

## Accesorios

Ver apartado accesorios.

